

SIZE: 2X2 1/2X9 TYPE: 410 IMPELLER: ENCLOSED R.P.M.: 2880

MAX. SPHERES 3 mm  
IMP. PATT. NO. 444A320  
CASE PATT. NO.  
180A015 UPPER (ALL)  
180A016 LOWER (411)  
180A068 LOWER (412 & 413)  
MIN. IMP. DIA. 152 mm

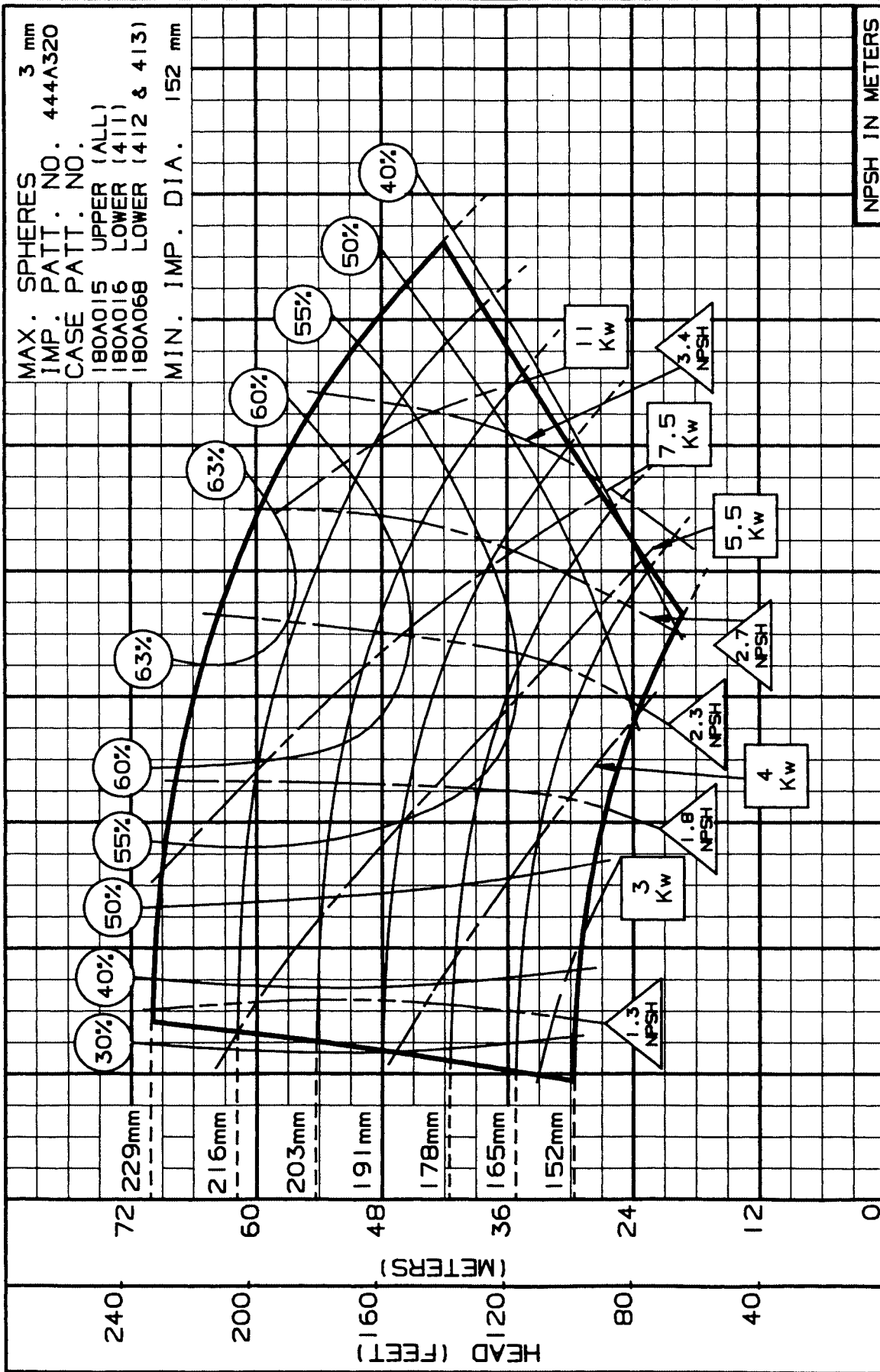

M <sup>3</sup> /HR	0	8	16	24	32	40	48	56	64	72
L/S	0	4	8	12	16	20	24	28	32	36
U.S. GPM	0	40	80	120	160	200	240	280	320	360
NPSH IN METERS										
DRAWN BY: <i>RAL</i> APPROVED BY: DL DATE: 7-90 PC-117351M										

2x2-1/2x9 - 1440 RPM  
 ENCLOSED IMPELLER



SIZE: 2X2 1/2X9 TYPE: 410 IMPELLER: ENCLOSED R.P.M.: 1440

MAX. SPHERES 3 mm  
 IMP. PATT. NO. 444A320  
 CASE PATT. NO.  
 180A015 UPPER (ALL)  
 180A016 LOWER (411)  
 180A068 LOWER (412 & 413)  
 MIN. IMP. DIA. 152 mm

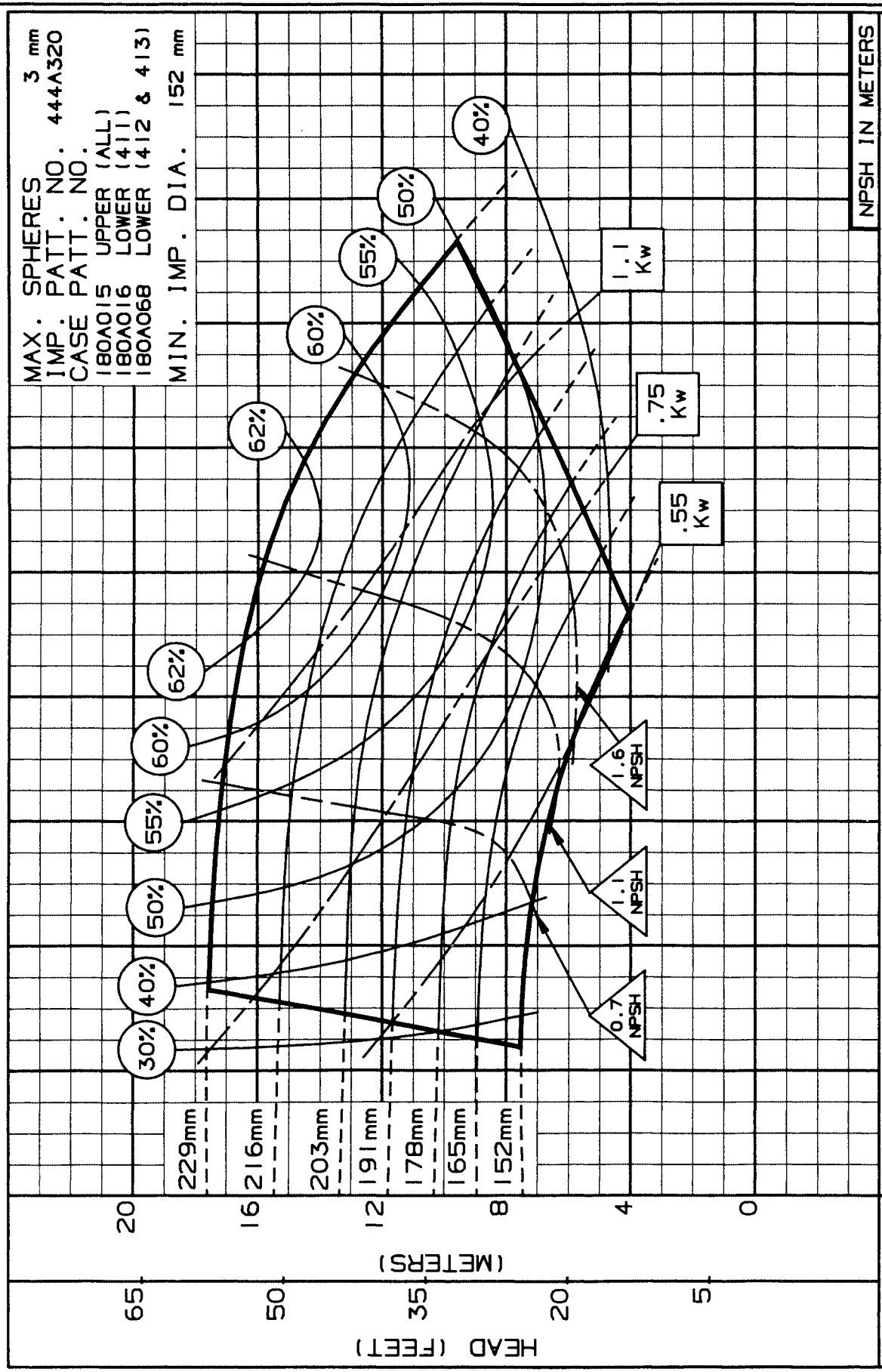

M <sup>3</sup> /HR	0	4	8	12	16	20	24	28	32	36
L/S		2	4	6	8					
U.S. GPM	20	40	60	80	100	120	140			
NPSH IN METERS										

DRAWN BY: RAYC APPROVED BY: DL DATE: 7-90 PC-117352M

SIZE: 2X2 1/2X10 TYPE: 410 IMPELLER: ENCLOSED R.P.M.: 2880

MAX. SPHERES 6 mm  
IMP. PATT. NO. 444A321  
CASE PATT. NO.  
180A017 UPPER (ALL)  
180A018 LOWER (411)  
180A069 LOWER (412 & 413)  
MIN. IMP. DIA. 165 mm

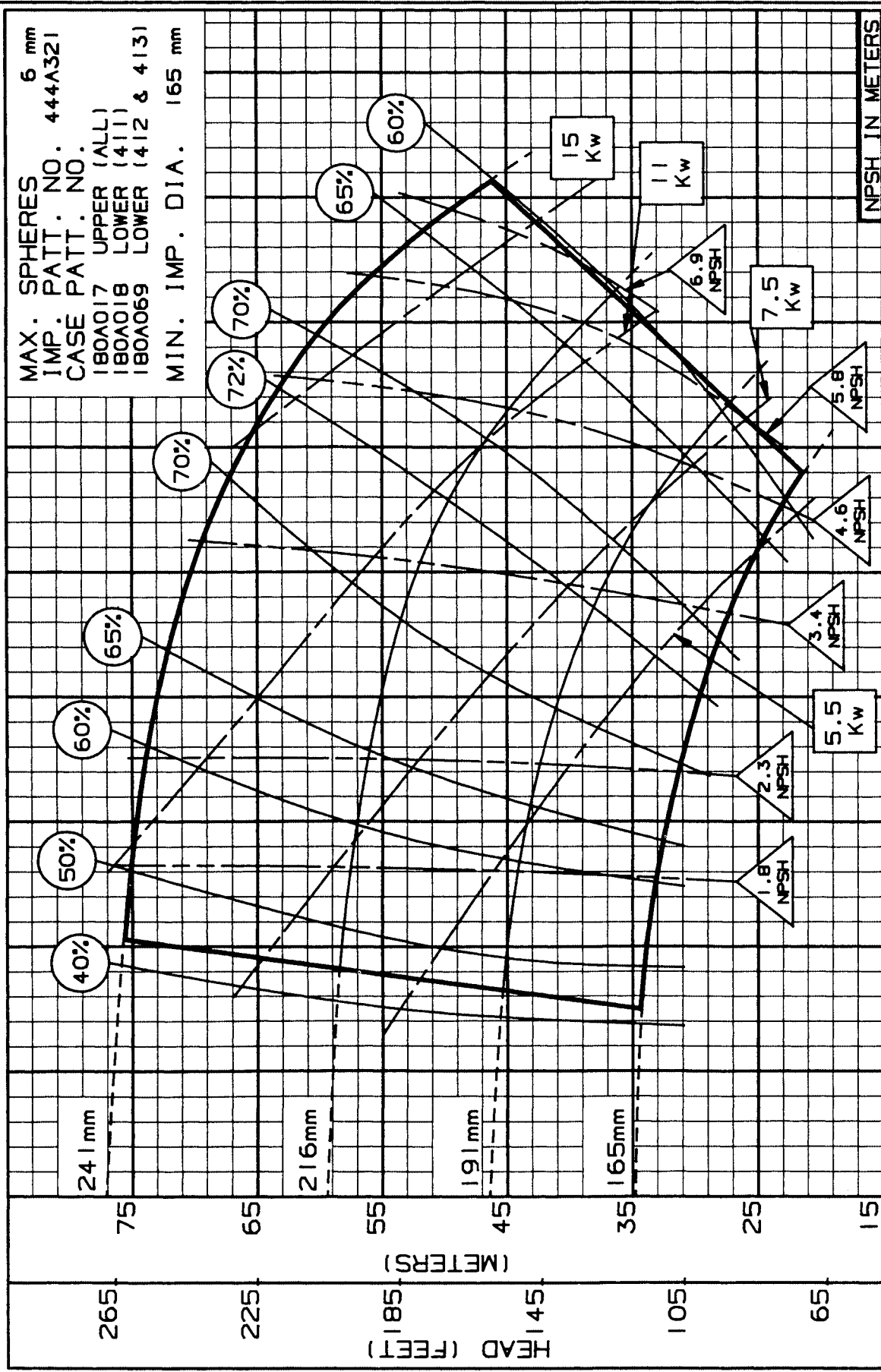

M <sup>3</sup> /HR	0	10	20	30	40	50	60	70	80	90
L/S	4	8	12	16	20	24	28	32	36	40
U.S. GPM	50	100	150	200	250	300	350	400	450	500
NPSH IN METERS										

DRAWN BY: *ATC* APPROVED BY: *DL* DATE: 7-90 PC-117353M

SECTION 410 (Metric 50Hz)  
 DATE JULY 1994  
 SUPERCEDES MARCH 1986

2x2-1/2x10 - 1440 RPM  
 ENCLOSED IMPELLER



SIZE: 2X2 1/2X10 TYPE: 410 IMPELLER: ENCLOSED R.P.M.: 1440

MAX. SPHERES 6 mm  
 IMP. PATT. NO. 444A321  
 CASE PATT. NO.  
 180A017 UPPER (ALL)  
 180A018 LOWER (411)  
 180A069 LOWER (412 & 413)  
 MIN. IMP. DIA. 165 mm

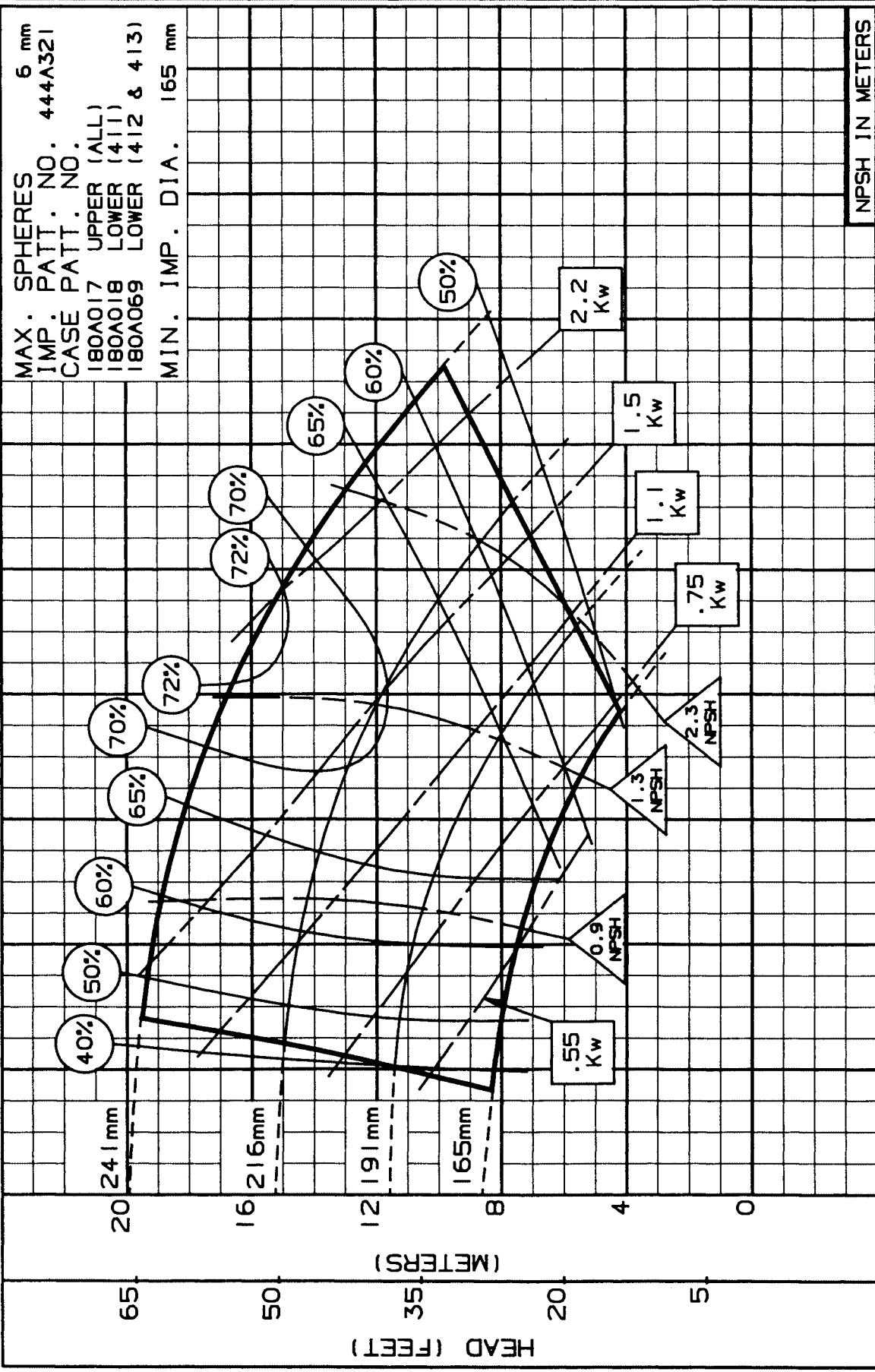

M <sup>3</sup> /HR	0	8	16	24	32	40	48	56	64	72
L/S	4	8	12	16	20	24	32	40	48	56
U.S. GPM	40	80	120	160	200	240	280	320	360	400
DRAWN BY: <i>ATL</i> APPROVED BY: DL DATE: 7-90 PC-117354M										

SIZE: 2X2 1/2X12 TYPE: 410 IMPELLER: ENCLOSED R.P.M.: 1440

MAX. SPHERES 6 mm  
IMP. PATT. NO. 444A322  
CASE PATT. NO.  
180A019 UPPER (ALL)  
180A020 LOWER (411)  
180A070 LOWER (412 & 413)  
MIN. IMP. DIA. 229 mm

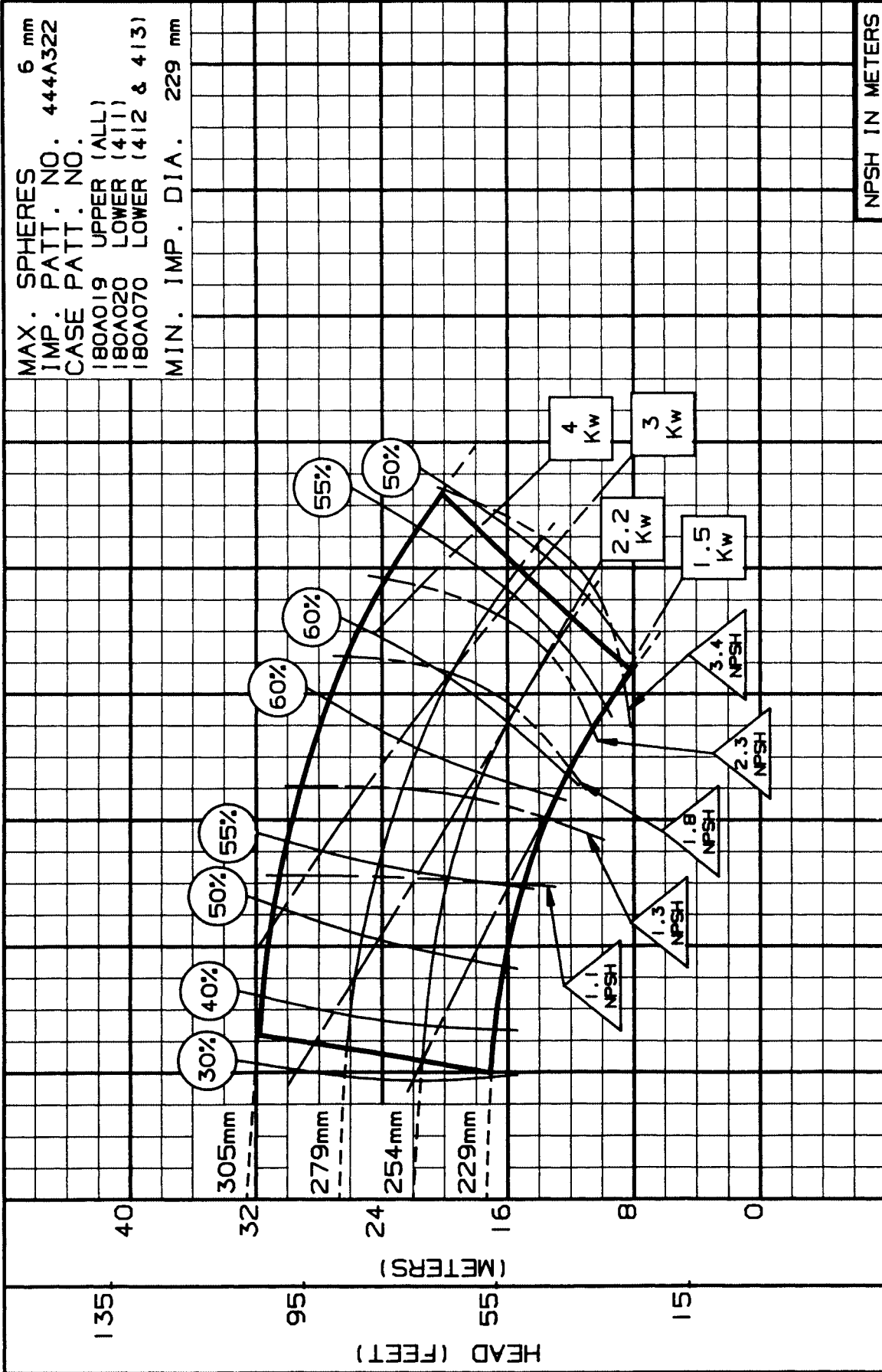

M <sup>3</sup> /HR	0	8	16	24	32	40	48	56	64	72
L/S	0	4	8	12	16	20	24	28	32	36
U.S. GPM	0	40	80	120	160	200	240	280	320	360
NPSH IN METERS										
0										
16										

DRAWN BY: *R. J. L.* APPROVED BY: DL DATE: 7-90 PC-117355M

SECTION 410 (Metric 50Hz)  
 DATE JULY 1994  
 SUPERCEDES MARCH 1986

2x2-1/2x12 - 960 RPM  
 ENCLOSED IMPELLER

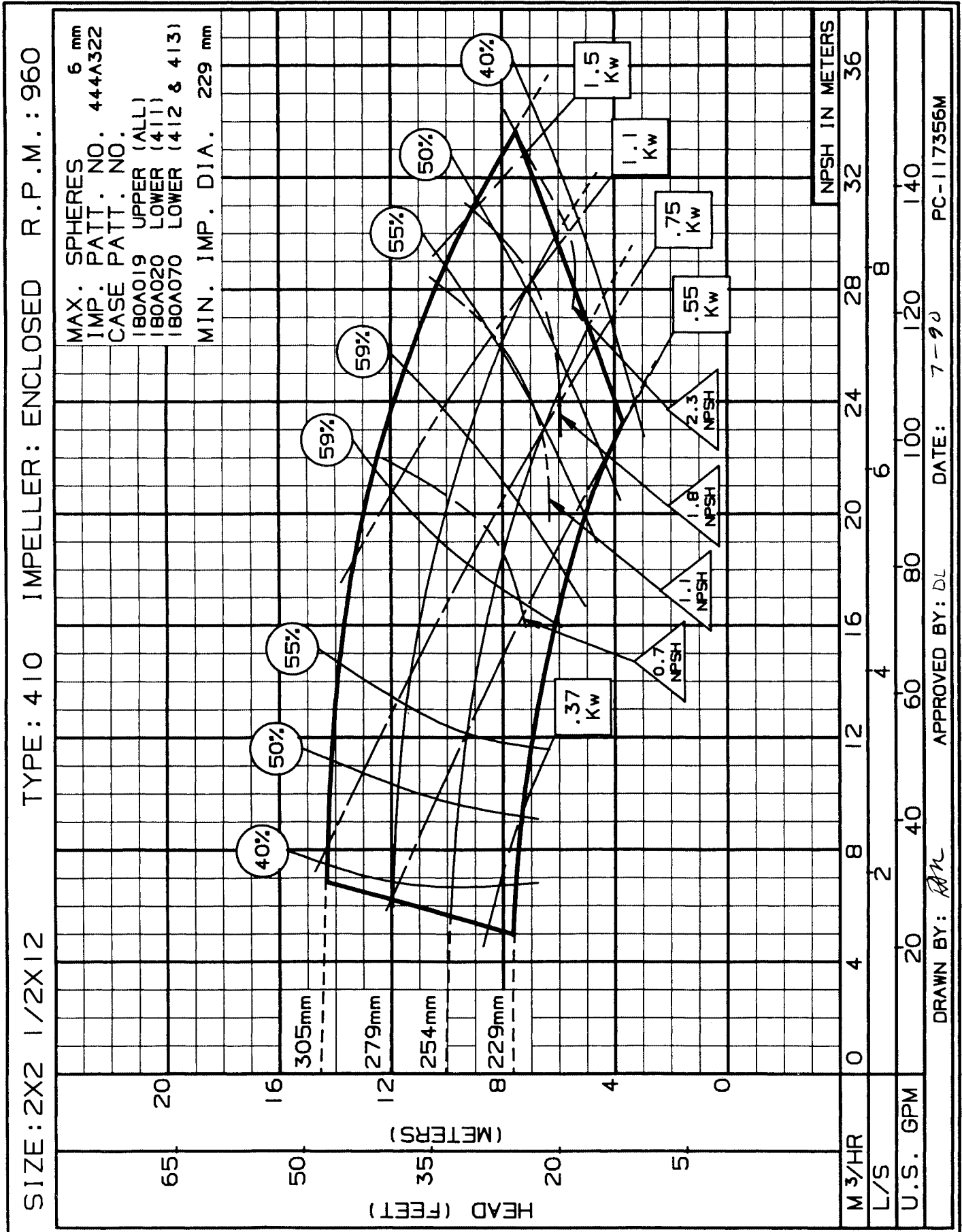

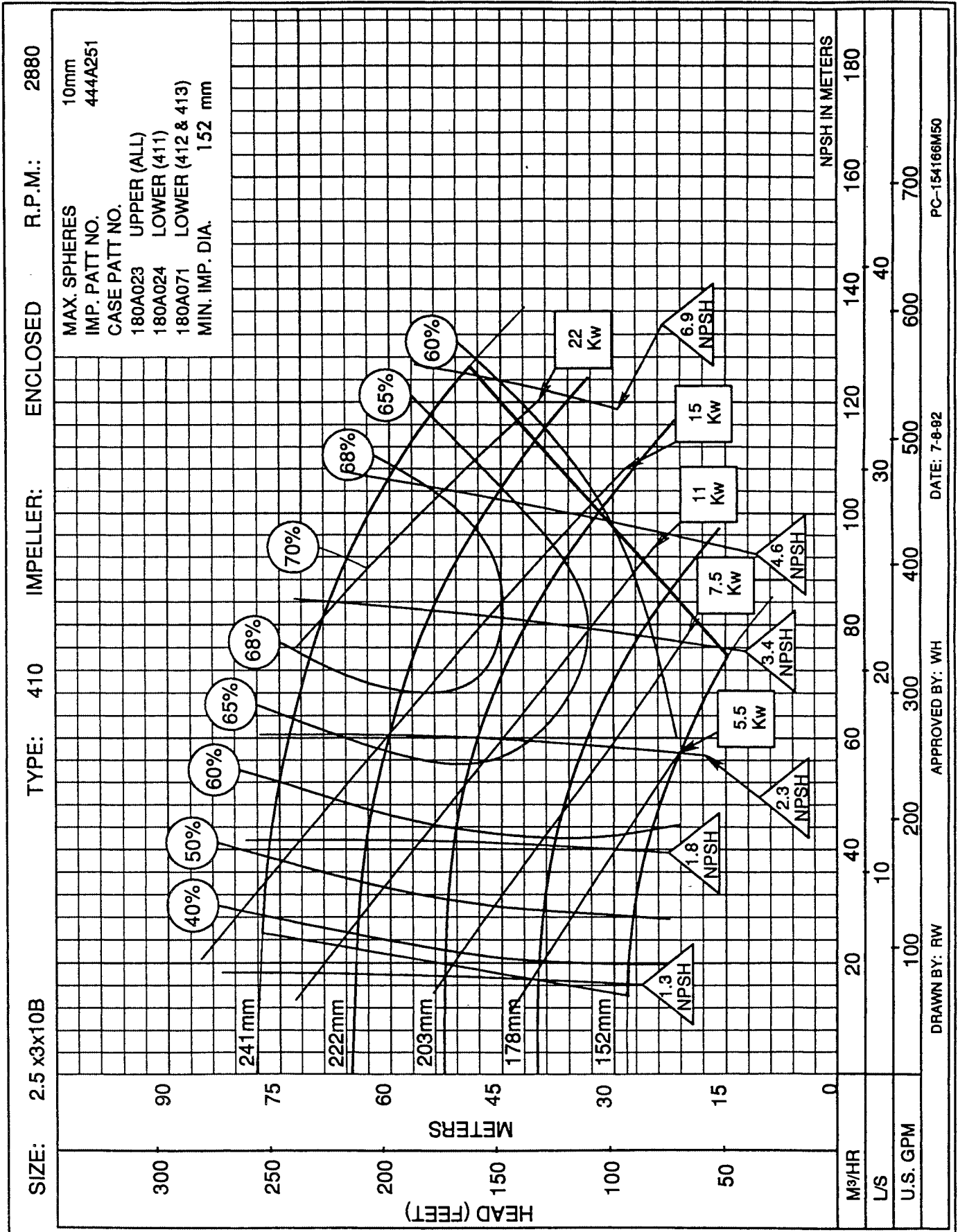

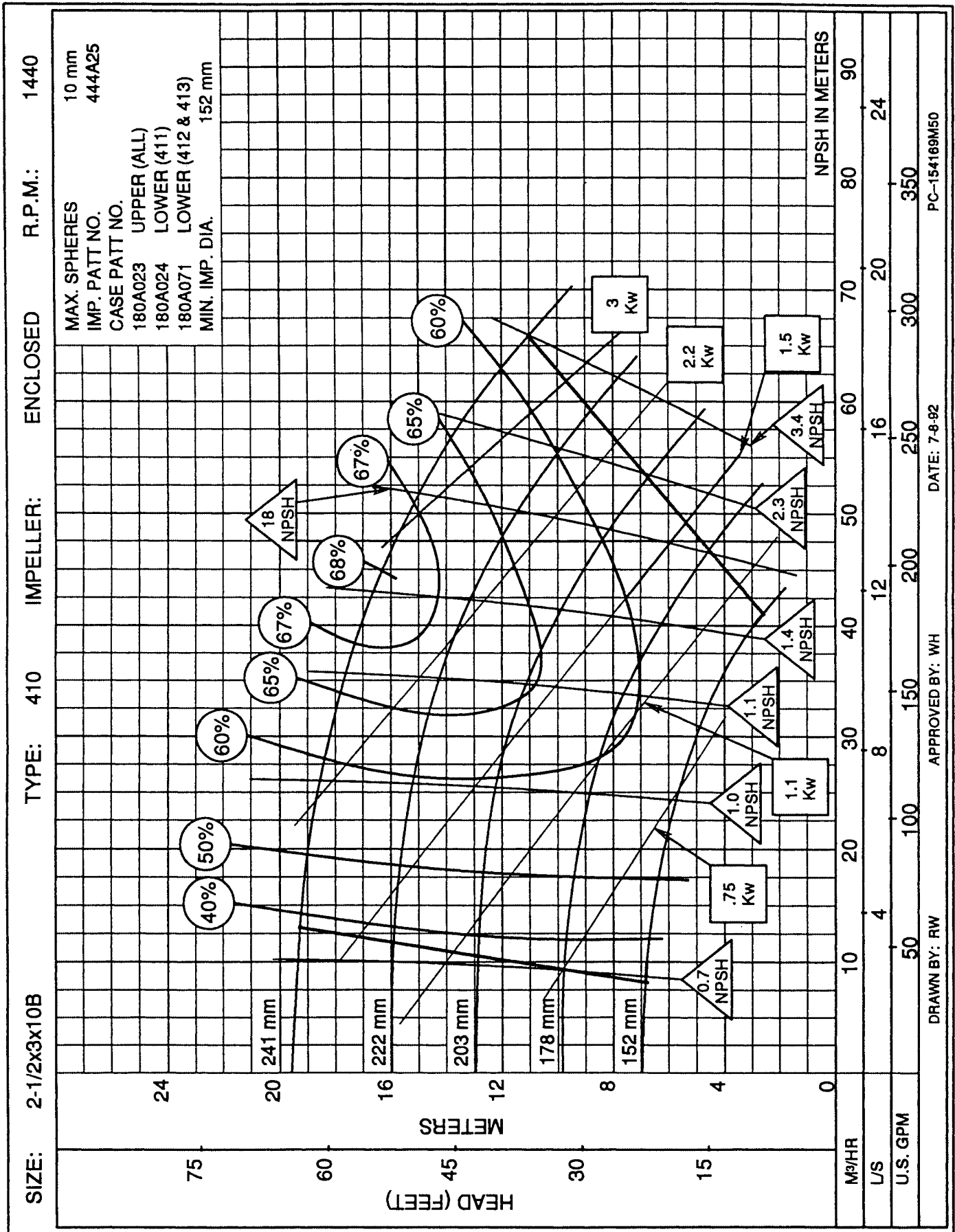

PC-154169M50

DATE: 7-8-92

APPROVED BY: WH

DRAWN BY: RW



SIZE: 2 1/2x3x12 TYPE: 410 IMPELLER: ENCLOSED R.P.M.: 1440

MAX. SPHERES 10 mm  
IMP. PATT. NO. 444A323  
CASE PATT. NO.  
180A025 UPPER (ALL)  
180A025 LOWER (411)  
180A072 LOWER (412 & 413)  
MIN. IMP. DIA. 229 mm

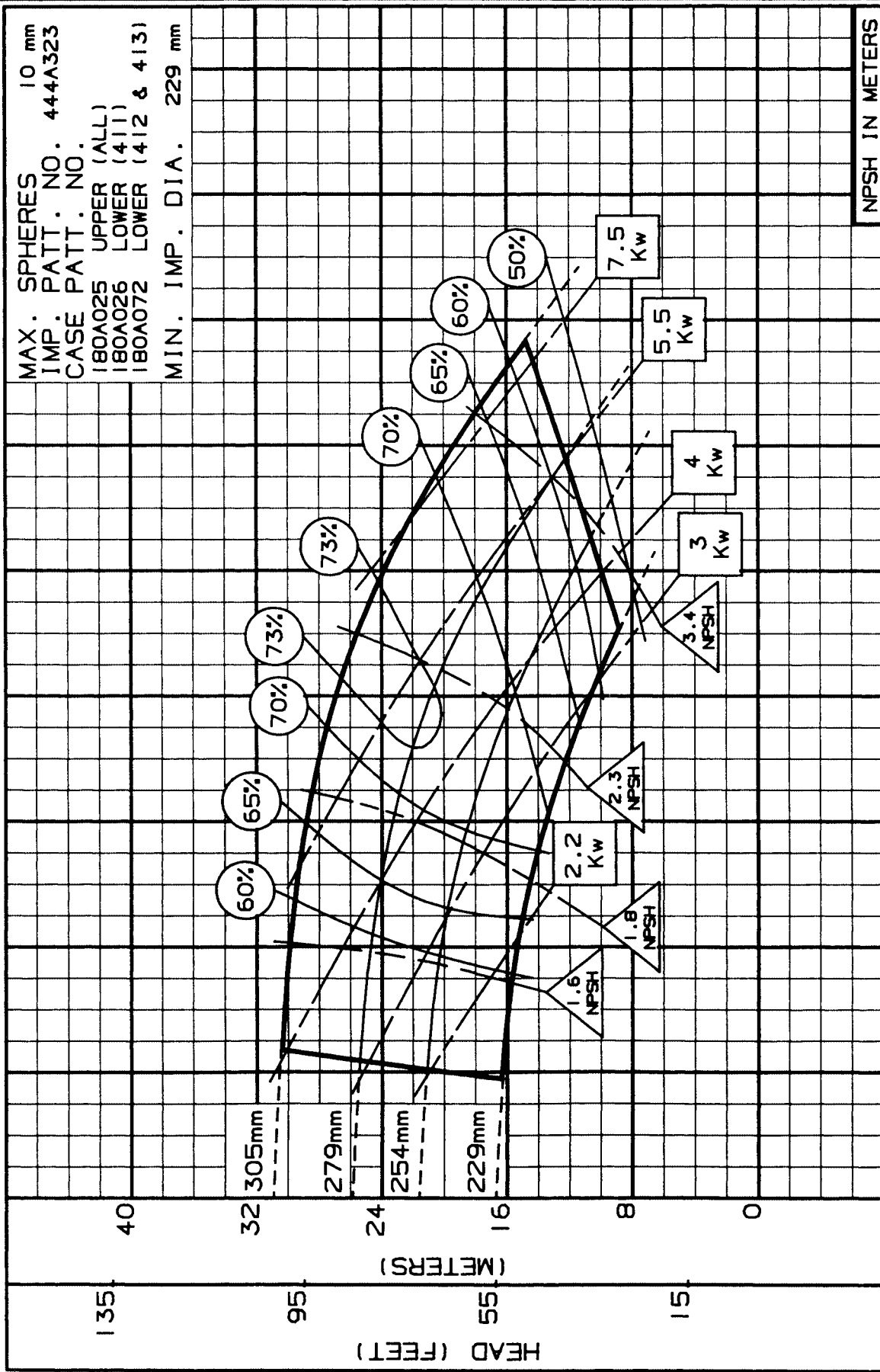

M <sup>3</sup> /HR	0	16	32	48	64	80	96	112	128	144
L/S	5	10	15	20	25	30	35	40	45	50
U.S. GPM	75	150	225	300	375	450	525	600	675	750
NPSH IN METERS										

DRAWN BY: *BA/C* APPROVED BY: DL DATE: 7-90 PC-117359M

2-1/2X3x12 - 960 RPM  
 ENCLOSED IMPELLER



SIZE: 2 1/2X3X12 TYPE: 410 IMPELLER: ENCLOSED R.P.M.: 960

MAX. SPHERES 10 mm  
 IMP. PATT. NO. 444A323  
 CASE PATT. NO.  
 180A025 UPPER (ALL)  
 180A026 LOWER (411)  
 180A072 LOWER (412 & 413)  
 MIN. IMP. DIA. 229 mm

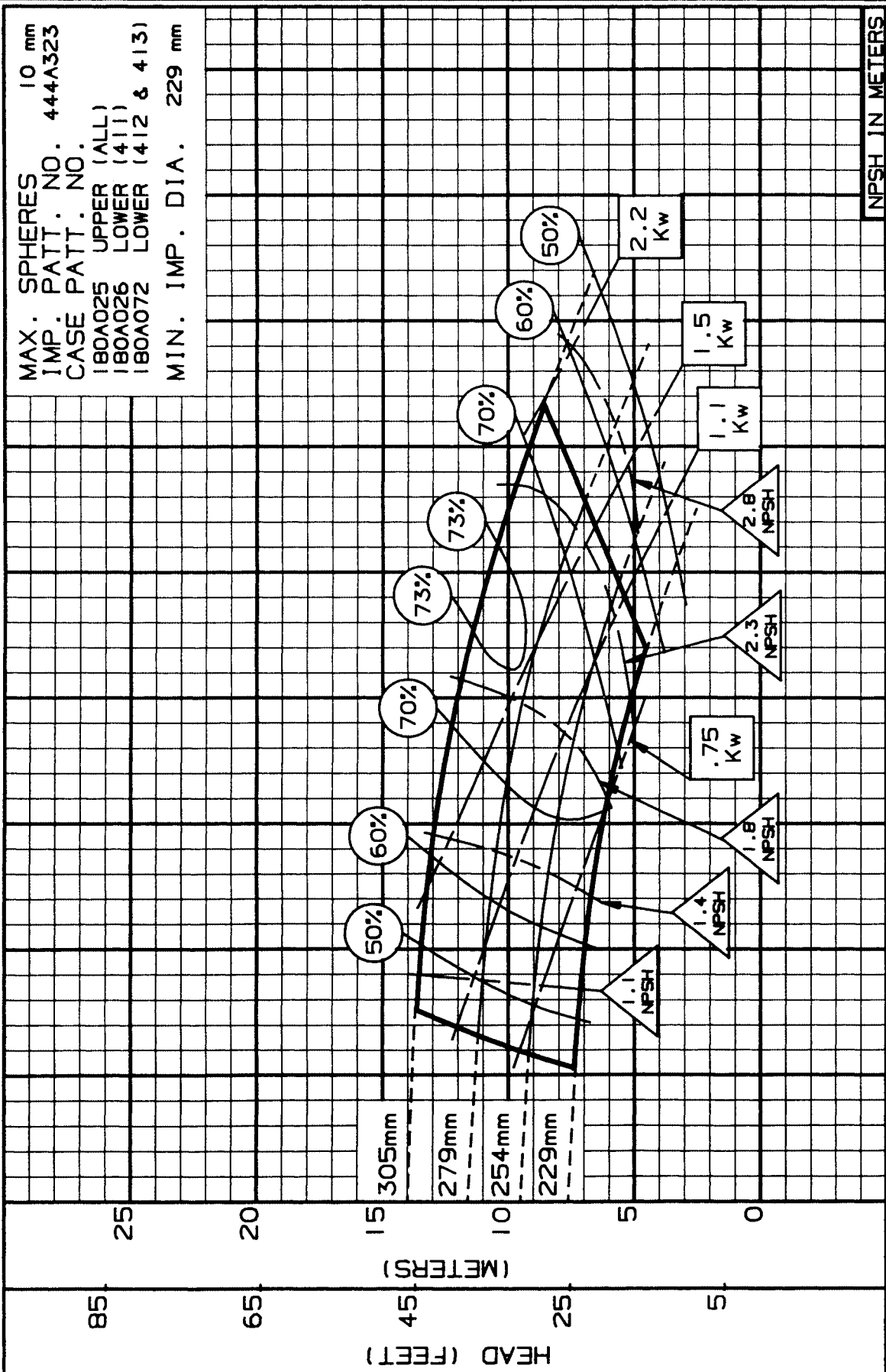

M <sup>3</sup> /HR	0	10	20	30	40	50	60	70	80	90
L/S	4	12	20	24	30	36	42	48	54	60
U.S. GPM	50	100	150	200	250	300	350	400	450	500
NPSH IN METERS										

DRAWN BY: *ABC* APPROVED BY: DL DATE: 7-9-94 PC-117360M

SIZE: 3X4X10B TYPE: 410 IMPELLER: ENCLOSED R.P.M.: 2880

MAX. SPHERES 13 mm  
IMP. PATT. NO. 444A131  
CASE PATT. NO.  
180A027 UPPER (ALL)  
180A028 LOWER (411)  
180A023 LOWER (412 & 413)  
MIN. IMP. DIA. 152 mm

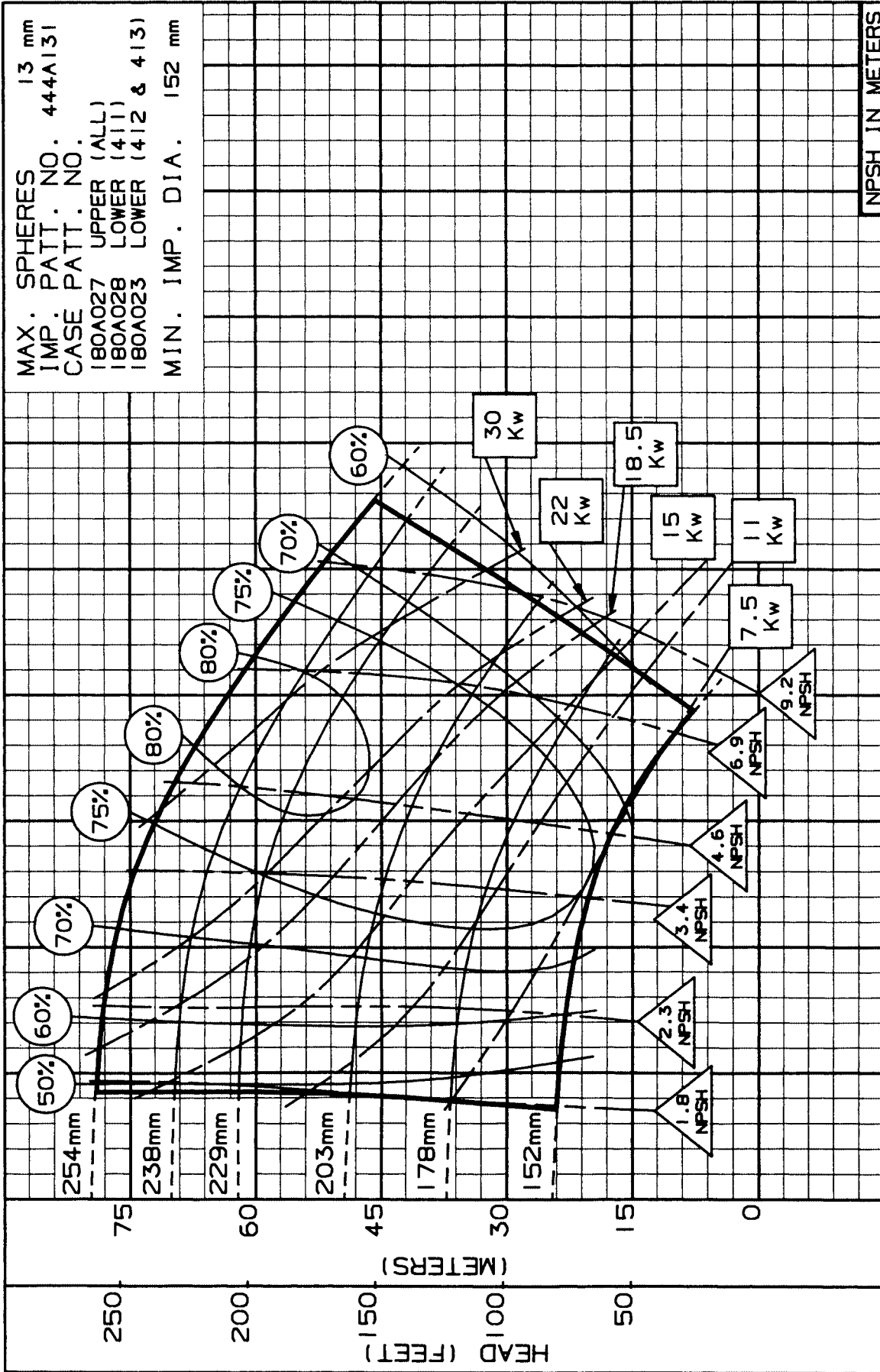

M <sup>3</sup> /HR	0	40	80	120	160	200	240	280	320	360
L/S	0	15	30	45	60	75	90	100	120	140
U.S. GPM	0	200	400	600	800	1000	1200	1400	1600	1800
NPSH IN METERS										

DRAWN BY: *AKC* APPROVED BY: DL DATE: 7-90 PC-124752M

SIZE: 3X4X10B TYPE: 410 IMPELLER: ENCLOSED R.P.M.: 1440

MAX. SPHERES 13 mm  
 IMP. PATT. NO. 444A131  
 CASE PATT. NO.  
 180A027 UPPER (ALL)  
 180A028 LOWER (411)  
 180A023 LOWER (412 & 413)  
 MIN. IMP. DIA. 152 mm

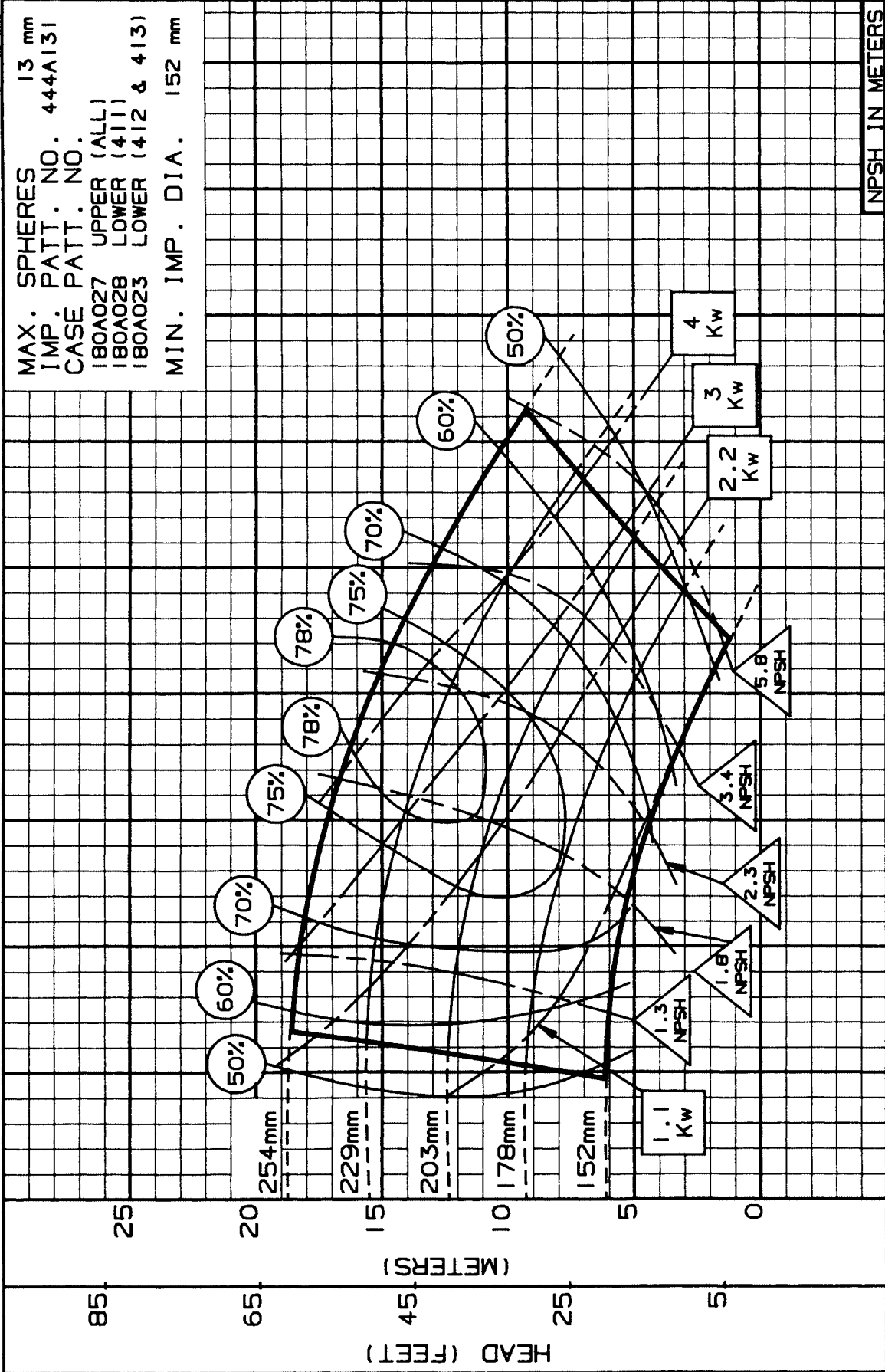

M <sup>3</sup> /HR	0	10	20	30	40	50	60	70	80	90	100	110	120	130	140	150	160	170	180	
L/S																				
U.S. GPM	100	200	300	400	500	600	700													
DRAWN BY: <i>RAN</i> APPROVED BY: <i>DL</i> DATE: 7-90 PC-124760M																				

SIZE: 3X4X10C TYPE: 410 IMPELLER: ENCLOSED R.P.M.: 2950

MAX. SPHERES 16 mm  
IMP. PATT. NO. 444A324  
CASE PATT. NO.  
180A027 UPPER (ALL)  
180A028 LOWER (411)  
180A023 LOWER (412 & 413)  
MIN. IMP. DIA. 178 mm

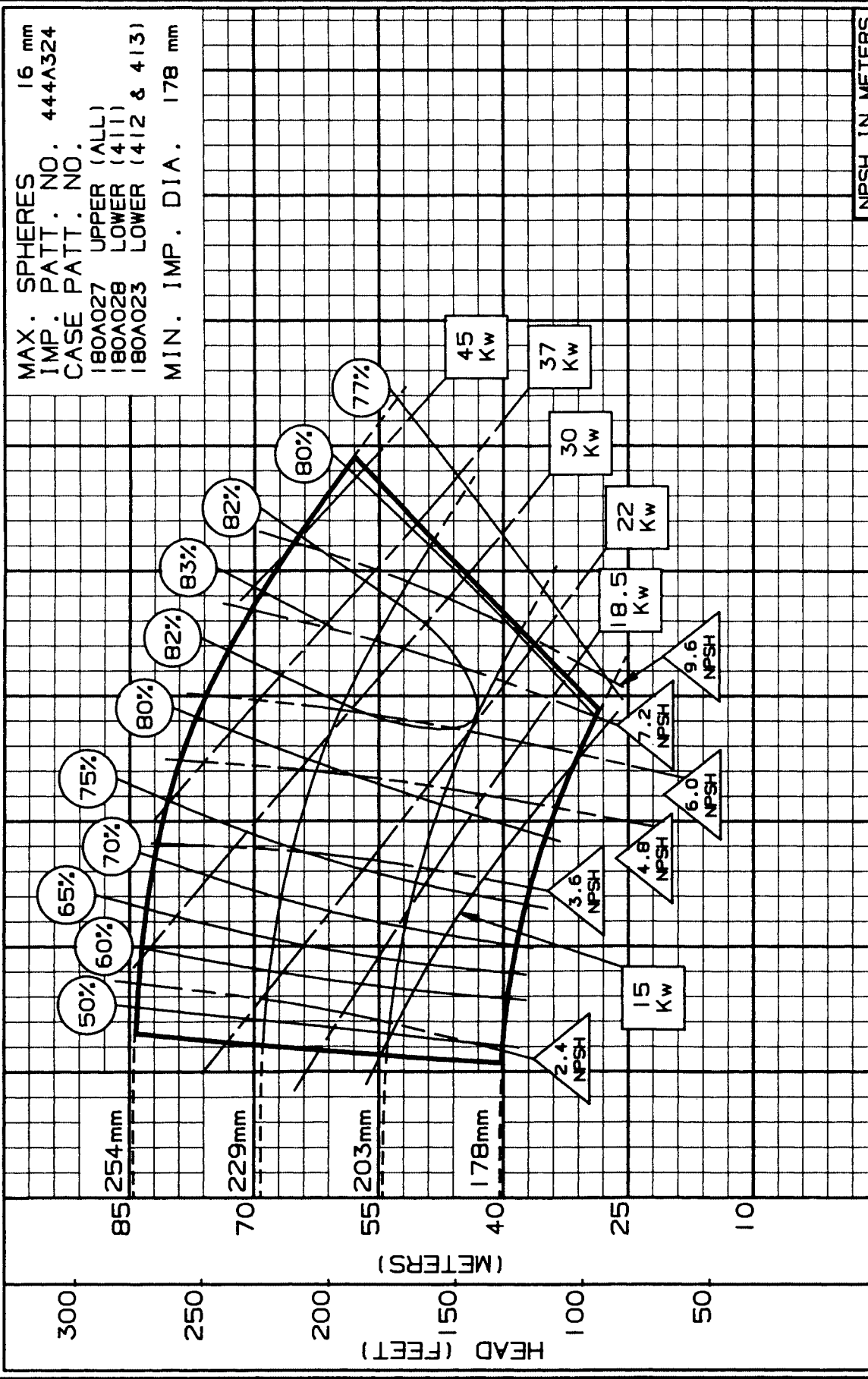

M <sup>3</sup> /HR	0	40	80	120	160	200	240	280	320	360
L/S	0	15	30	45	60	75	90	105	120	135
U.S. GPM	0	200	400	600	800	1000	1200	1400	1600	1800
DRAWN BY: <i>AK</i> APPROVED BY: DL DATE: 7-90 PC-146727M										

3x4x10C - 1440 RPM  
 ENCLOSED IMPELLER

SIZE: 3X4X10C TYPE: 410 IMPELLER: ENCLOSED R.P.M.: 1440

MAX. SPHERES 16 mm  
 IMP. PATT. NO. 444A324  
 CASE PATT. NO.  
 180A027 UPPER (ALL)  
 180A028 LOWER (411)  
 180A023 LOWER (412 & 413)  
 MIN. IMP. DIA. 178 mm

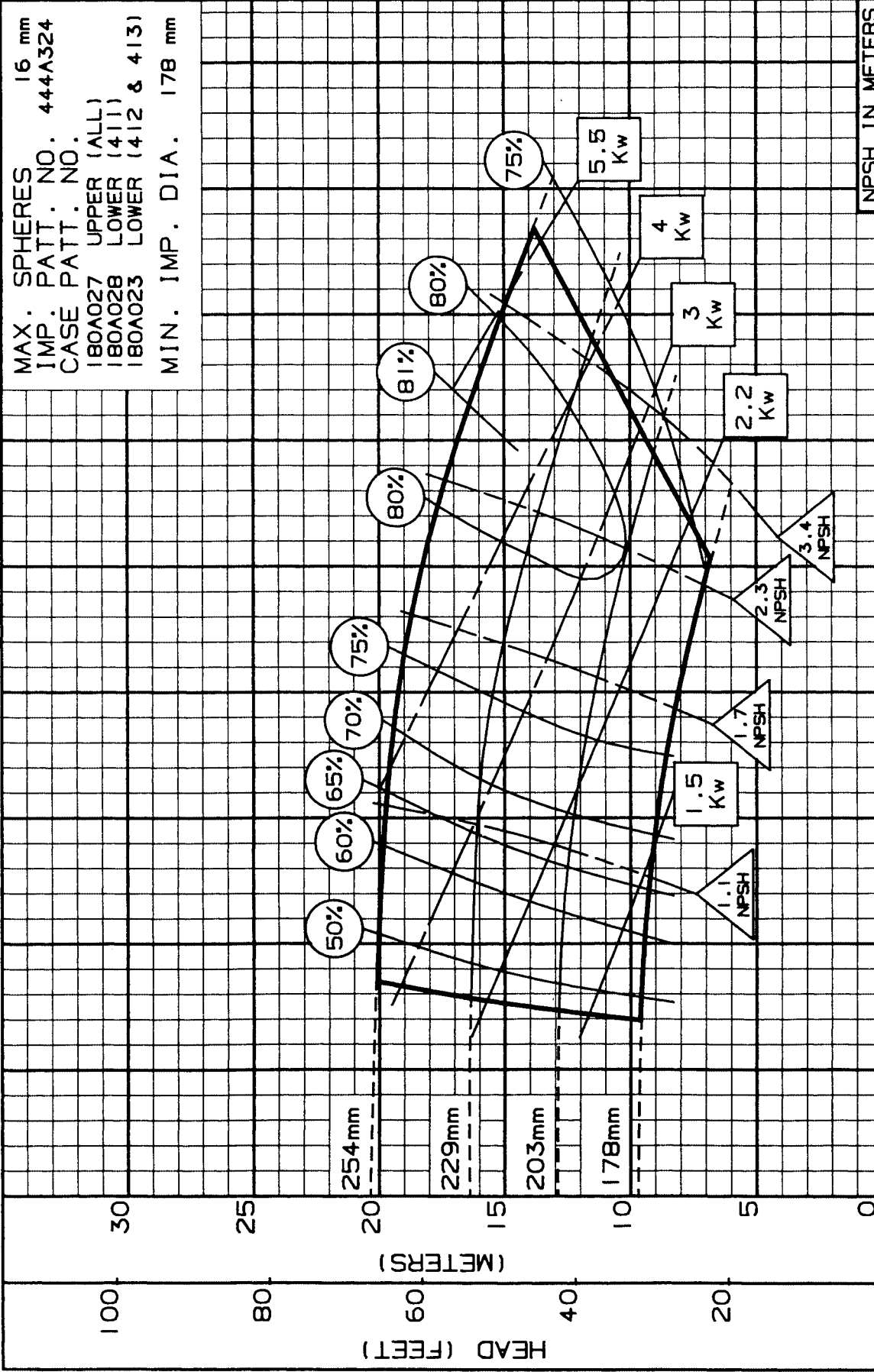

M <sup>3</sup> /HR	0	15	30	45	60	75	90	105	120	135
L/S	0	5	10	15	20	25	30	35	40	45
U.S. GPM	0	75	150	225	300	375	450	525	600	675
NPSH IN METERS										
DRAWN BY: <i>AMC</i> APPROVED BY: DL DATE: 7-90 PC-146728M										

SIZE: 3X4X14 TYPE: 410 IMPELLER: ENCLOSED R.P.M.: 1440

MAX. SPHERES 16 mm  
IMP. PATT. NO. 444A324  
CASE PATT. NO.  
180A029 UPPER (ALL)  
180A030 LOWER (411)  
180A074 LOWER (412 & 413)  
MIN. IMP. DIA. 248 mm

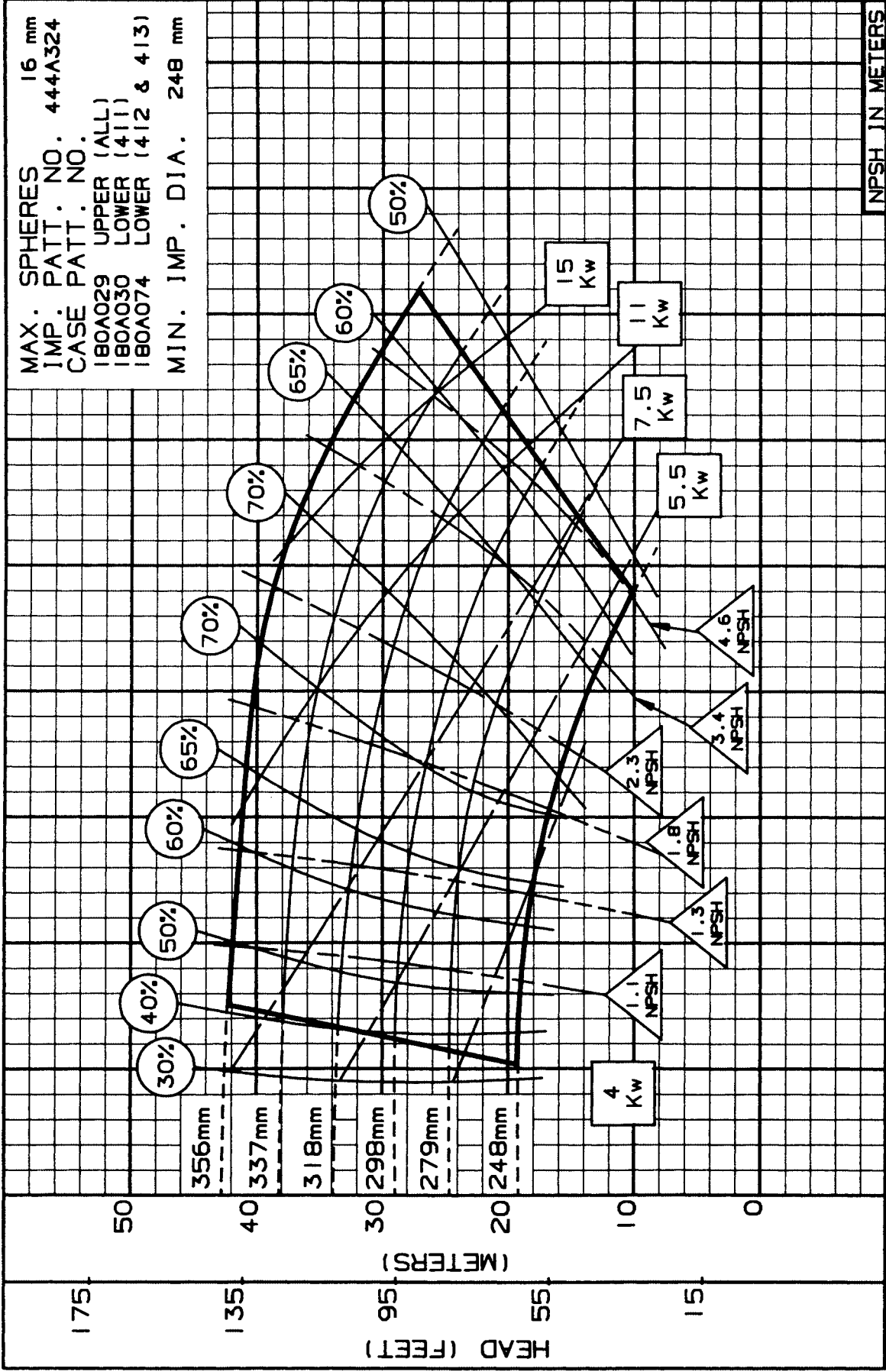

M <sup>3</sup> /HR	0	20	40	60	80	100	120	140	160	180	NPSH IN METERS
L/S		10	20	30	40	50	60	70	80	90	
U.S. GPM	0	100	200	300	400	500	600	700	800	900	
DRAWN BY: <i>ATL</i> APPROVED BY: DL DATE: 7-94 PC-117363M											

SIZE: 3X4X14 TYPE: 410 IMPELLER: ENCLOSED R.P.M.: 960

MAX. SPHERES 16 mm  
 IMP. PATT. NO. 444A324  
 CASE PATT. NO.  
 180A029 UPPER (ALL)  
 180A030 LOWER (411)  
 180A074 LOWER (412 & 413)  
 MIN. IMP. DIA. 248 mm

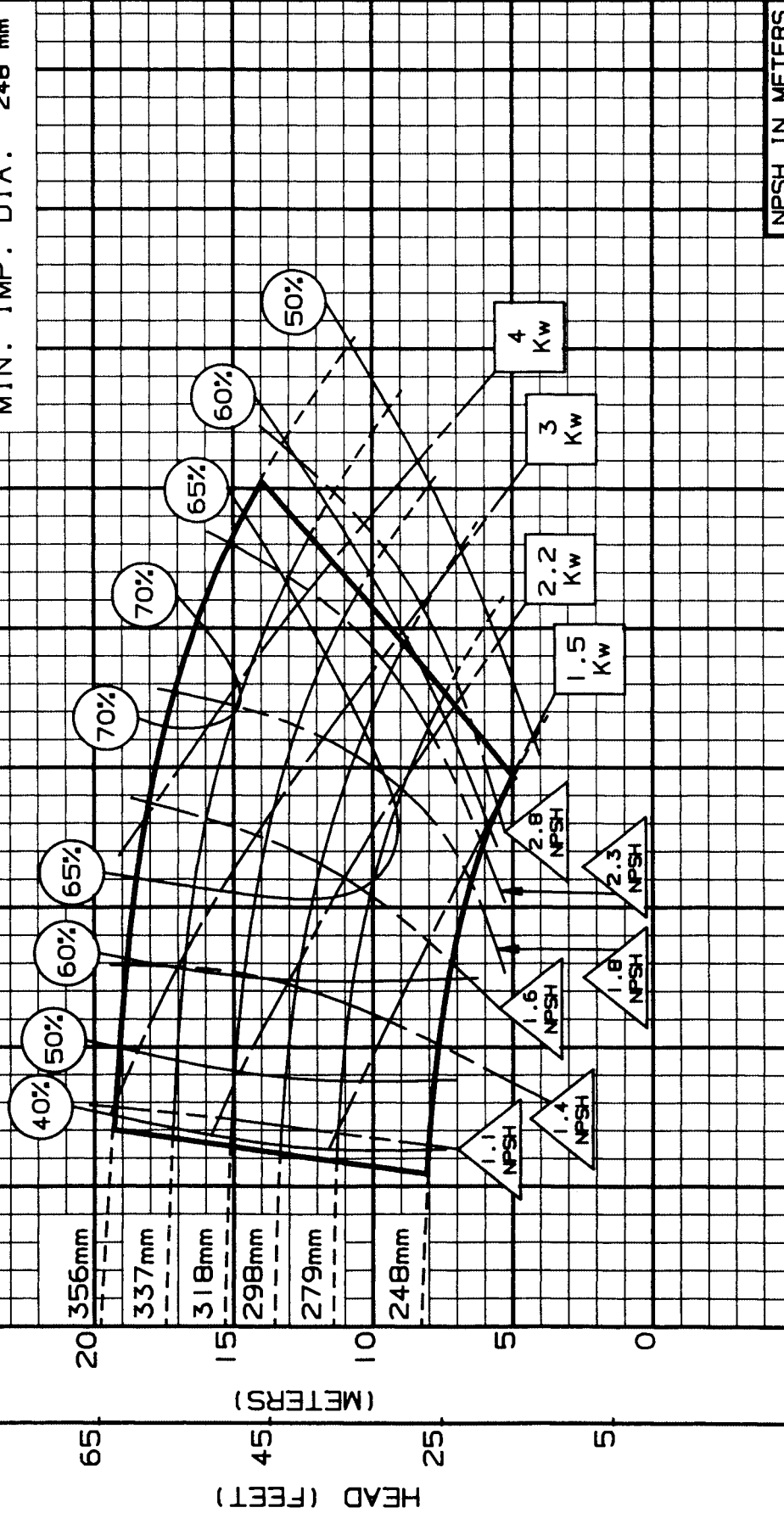

M <sup>3</sup> /HR	0	15	30	45	60	75	90	105	120	135
L/S	5	10	15	20	25	30	35	40	45	50
U.S. GPM	75	150	225	300	375	450	525	600	675	750

DRAWN BY: *RAM* APPROVED BY: *DL* DATE: 7-90 PC-117364M



SIZE: 4X5X10B TYPE: 410 IMPELLER: ENCLOSED R.P.M.: 2880

MAX. SPHERES 16 mm  
IMP. PATT. NO. 444A133  
CASE PATT. NO.  
180A027 UPPER (ALL)  
180A032 LOWER (411)  
180A075 LOWER (412 & 413)  
MIN. IMP. DIA. 146 mm

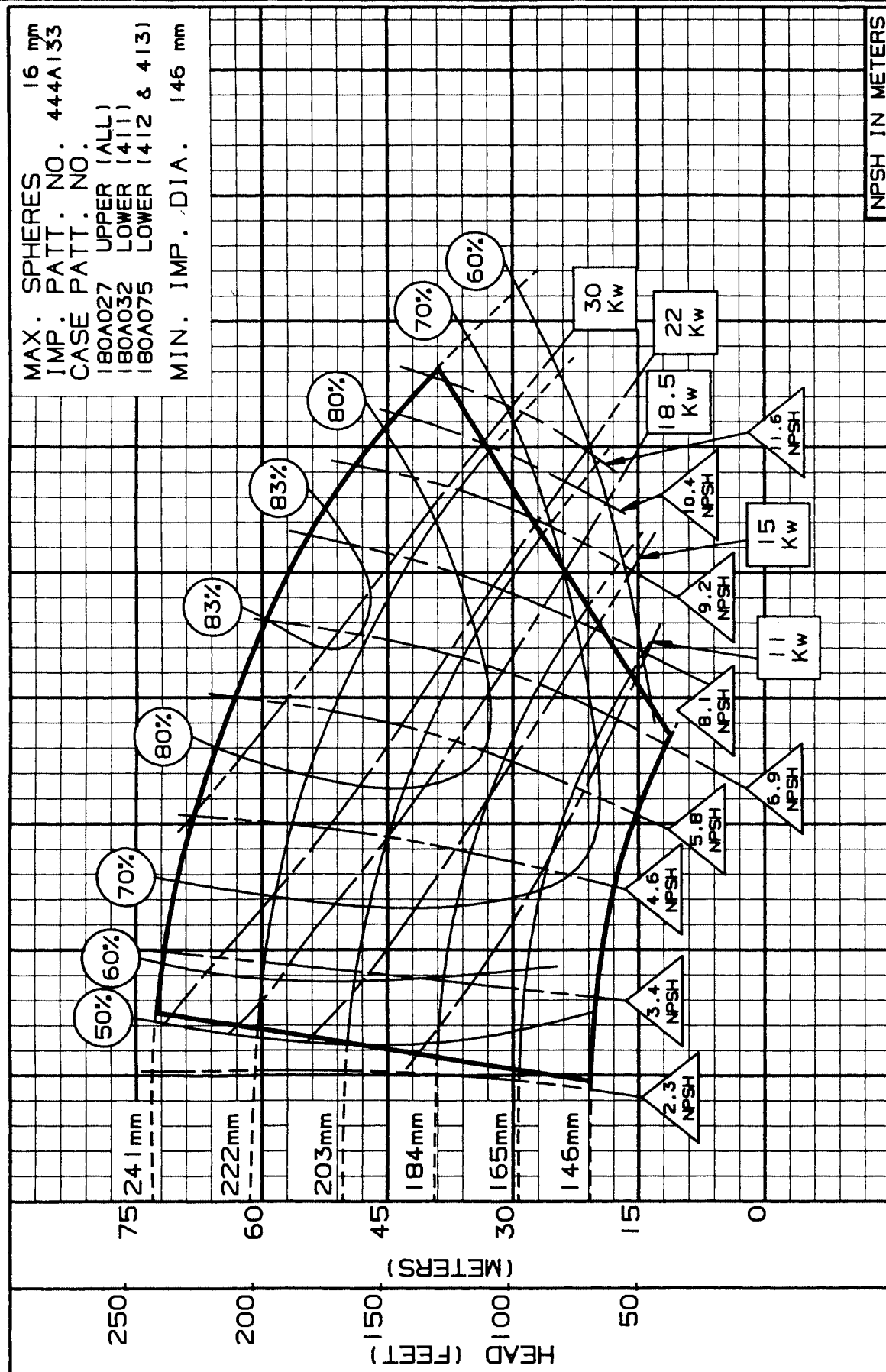

M <sup>3</sup> /HR	0	40	80	120	160	200	240	280	320	360
L/S		15	30	45	60	75	90	100	120	140
U.S. GPM	200	400	600	800	1000	1200	1400	1600	1800	2000
NPSH IN METERS										

DRAWN BY: *AWL* APPROVED BY: *DL* DATE: 7-90 PC-117367M

SIZE: 4X5X10B TYPE: 410 IMPELLER: ENCLOSED R.P.M.: 1440

MAX. SPHERES 16 mm  
 IMP. PATT. NO. 444A133  
 CASE PATT. NO.  
 180A027 UPPER (ALL)  
 180A032 LOWER (411)  
 180A075 LOWER (412 & 413)  
 MIN. IMP. DIA. 146 mm

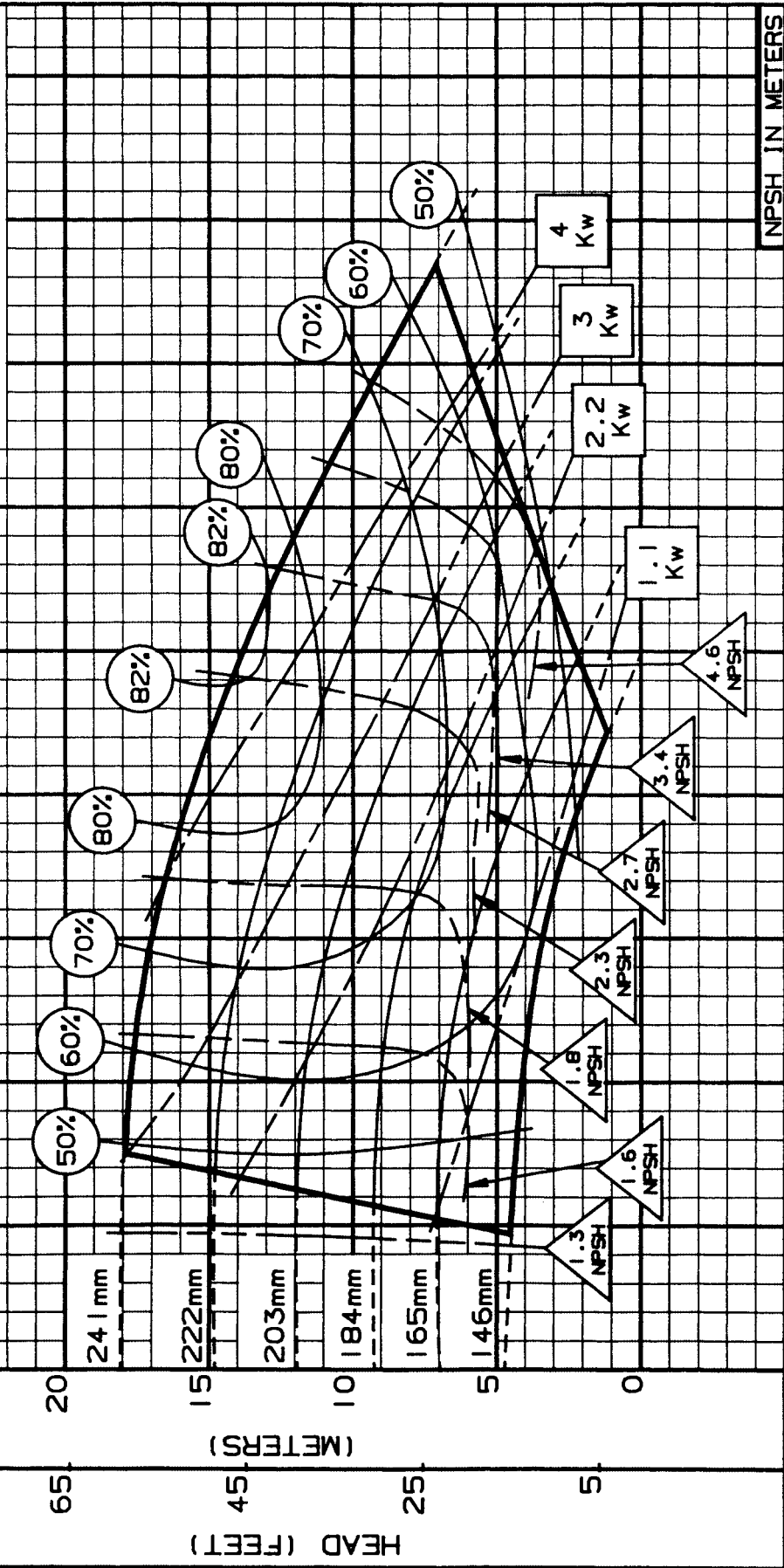

M <sup>3</sup> /HR	0	10	20	30	40	50	60	70	80	90	100	110	120	130	140	150	160	170	180	
L/S																				
U.S. GPM	0	100	200	300	400	500	600	700												
NPSH IN METERS																				

DRAWN BY: *RPN* APPROVED BY: DL DATE: 7-90 PC-117368M

SIZE: 4X5X11A TYPE: 410 IMPELLER: ENCLOSED R.P.M.: 1440

MAX. SPHERES 16 mm  
IMP. PATT: NO. 444A325  
CASE PATT: NO.  
180A035 UPPER (ALL)  
180A036 LOWER (411)  
180A076 LOWER (412 & 413)  
MIN. IMP. DIA. 203 mm

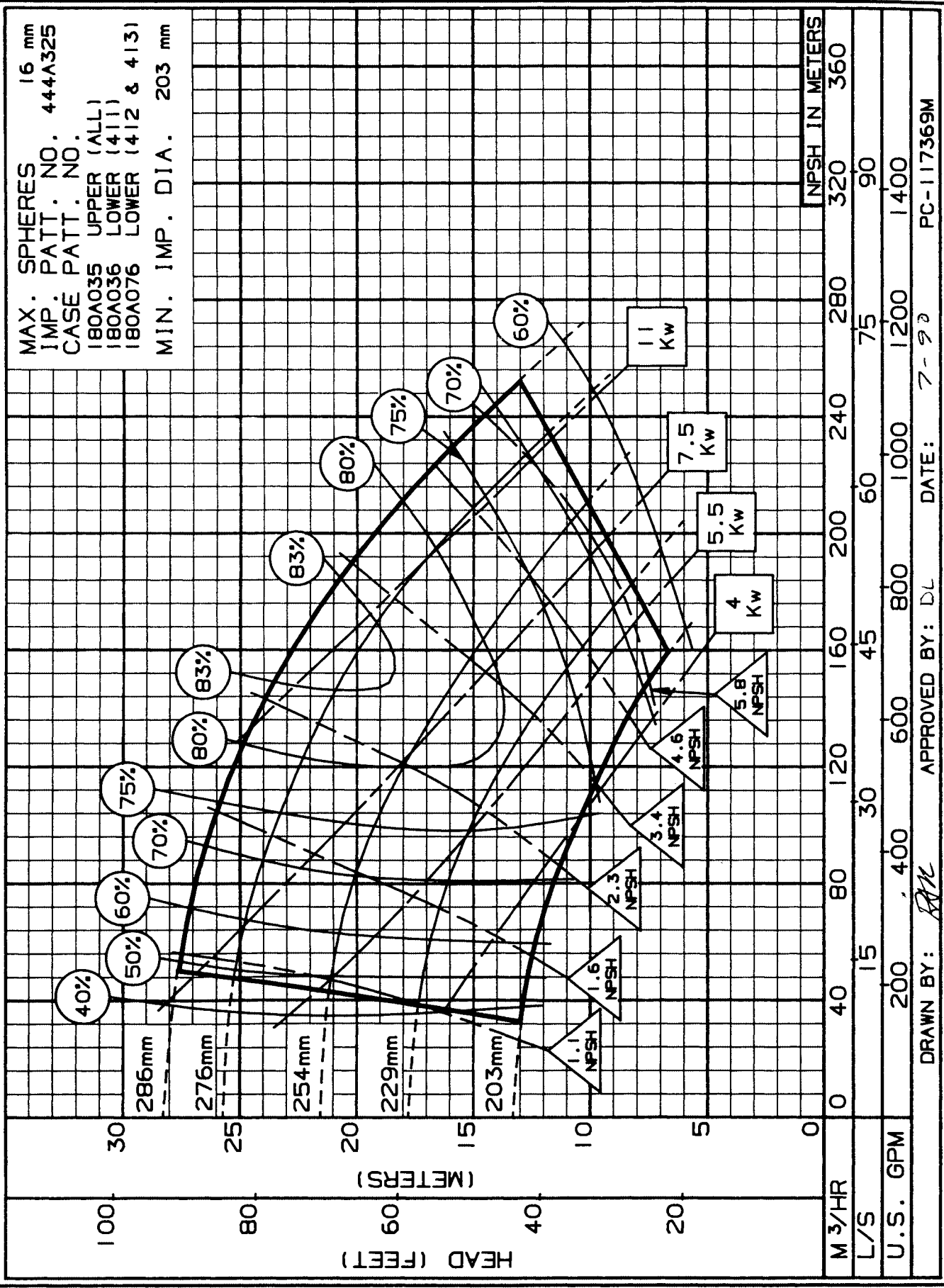

M <sup>3</sup> /HR	0	40	80	120	160	200	240	280	320	360
L/S	0	15	30	45	60	75	90	100	120	140
U.S. GPM	0	200	400	600	800	1000	1200	1400	1600	1800
NPSH IN METERS										

DRAWN BY: *SK* APPROVED BY: DL DATE: 7-90 PC-117369M

4x5x11A - 960 RPM

ENCLOSED IMPELLER



Pentair Pump Group

SIZE: 4X5X11A TYPE: 410 IMPELLER: ENCLOSED R.P.M.: 960

MAX. SPHERES 16 mm  
 IMP. PATT. NO. 444A325  
 CASE PATT. NO.  
 180A035 UPPER (ALL)  
 180A036 LOWER (411)  
 180A076 LOWER (412 & 413)  
 MIN. IMP. DIA. 203 mm

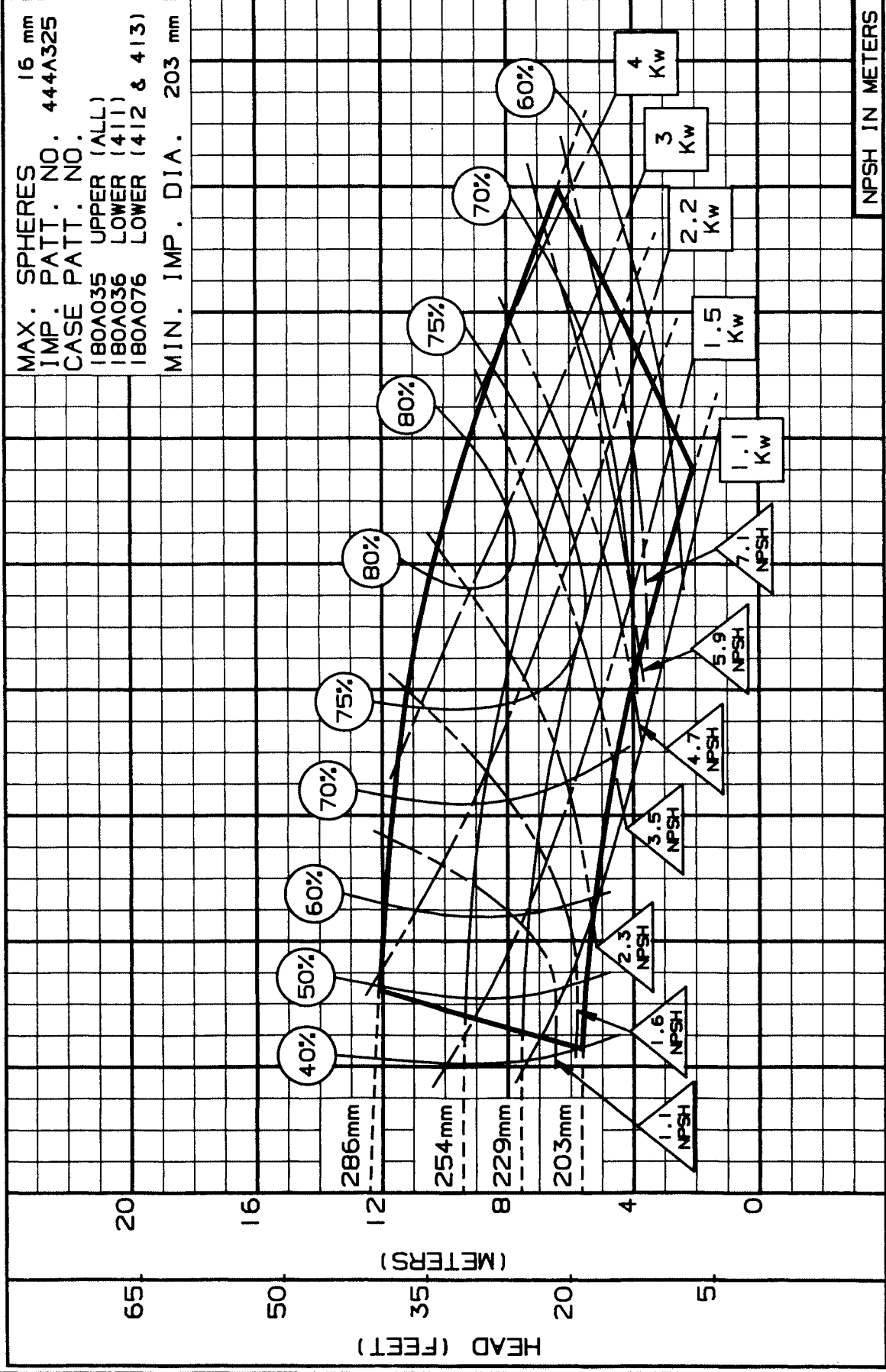

M <sup>3</sup> /HR	0	20	40	60	80	100	120	140	160	180
L/S	0	10	20	30	40	50	60	70	80	90
U.S. GPM	0	100	200	300	400	500	600	700	800	900
DRAWN BY: <i>AKZ</i> APPROVED BY: DL DATE: 7-90 PC-117370M										

SIZE: 4X5X11C TYPE: 410 IMPELLER: ENCLOSED R.P.M.: 2950

MAX. SPHERES 13 mm  
IMP. PATT. NO. 444A135  
CASE PATT. NO.  
180A035 UPPER (ALL)  
180A036 LOWER (411)  
180A076 LOWER (412 & 413)  
MIN. IMP. DIA. 184 mm

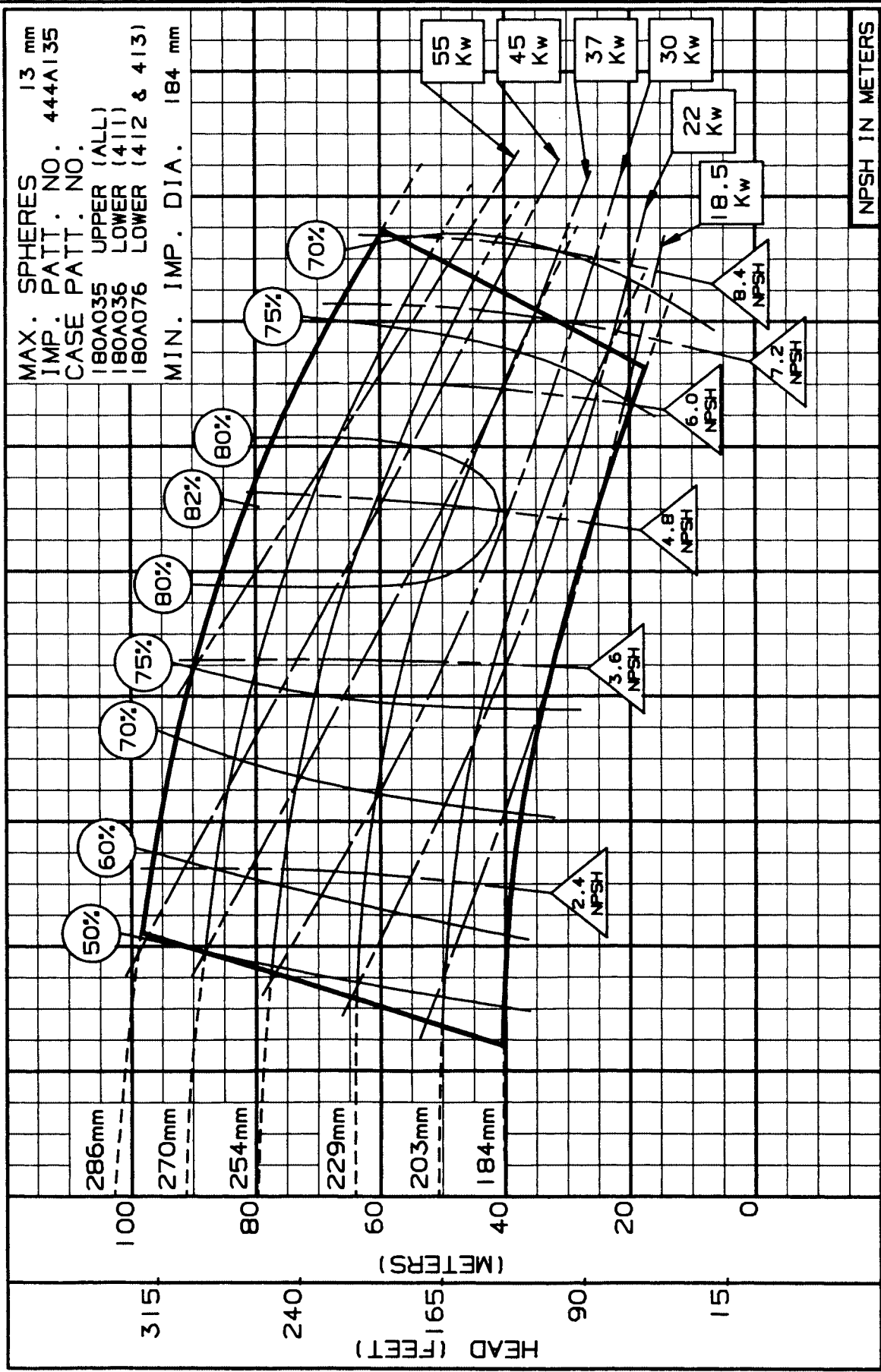

M <sup>3</sup> /HR	0	40	80	120	160	200	240	280	320	360
L/S	15	30	45	60	75	90	100	1200	1400	
U.S. GPM	200	400	600	800	1000	1200	1400			
DRAWN BY: <i>SAX</i> APPROVED BY: DL DATE: 7-90 PC-148337M										

4x5x11C - 1440 RPM

ENCLOSED IMPELLER



Pentair Pump Group

SIZE: 4X5X11C TYPE: 410 IMPELLER: ENCLOSED R.P.M.: 1440

MAX. SPHERES 13 mm  
 IMP. PATT. NO. 444A135  
 CASE PATT. NO.  
 180A035 UPPER (ALL)  
 180A036 LOWER (411)  
 180A076 LOWER (412 & 413)  
 MIN. IMP. DIA. 184 mm

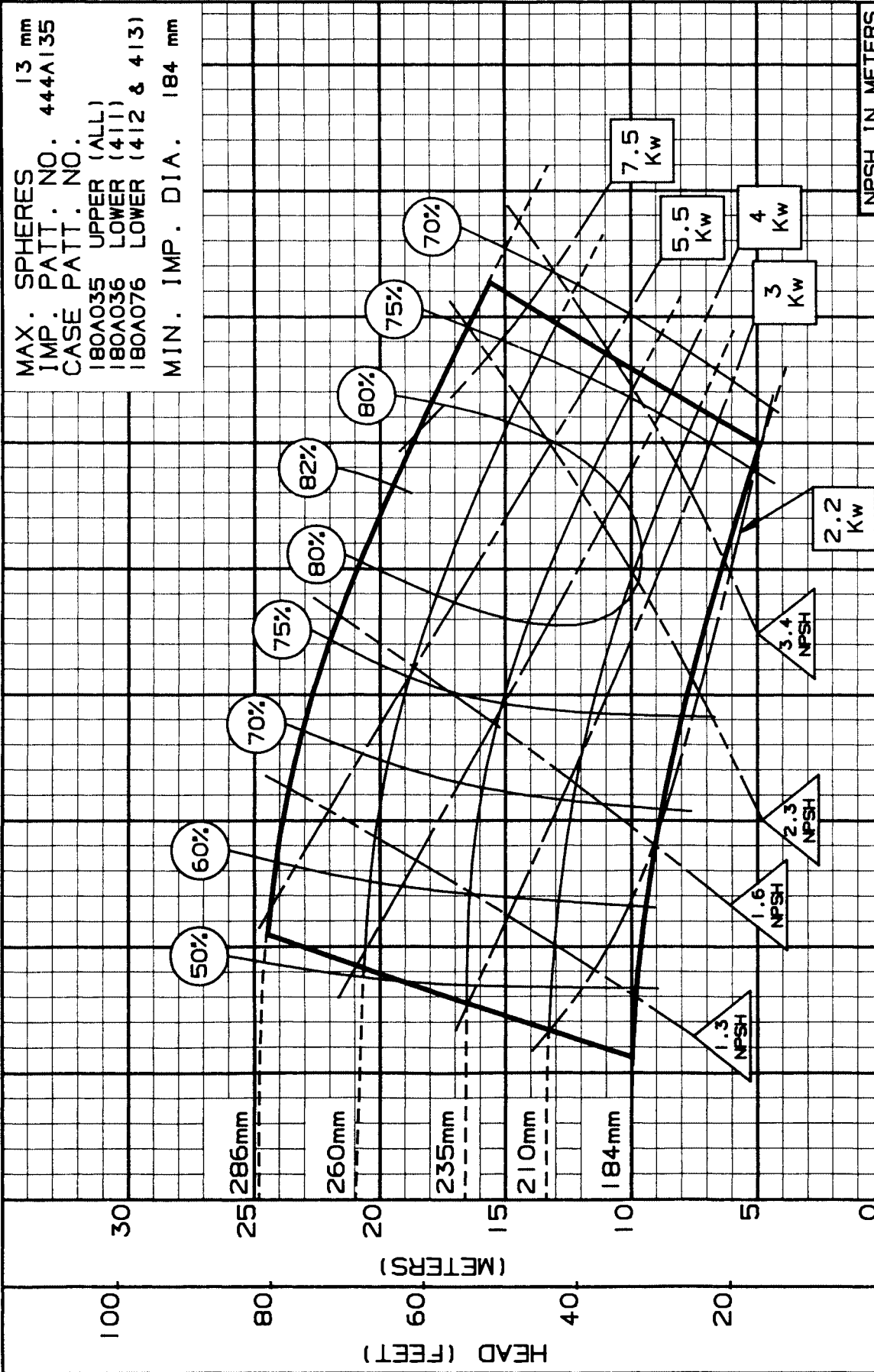

M <sup>3</sup> /HR	0	20	40	60	80	100	120	140	160	180
L/S	0	10	20	30	40	50	60	70	80	90
U.S. GPM	0	100	200	300	400	500	600	700	800	900

DATE: 7-90  
 APPROVED BY: DL  
 DRAWN BY: RAZ  
 PC-117372M

SIZE: 4X5X15 TYPE: 410 IMPELLER: ENCLOSED R.P.M.: 1440

MAX. SPHERES 16 mm  
IMP. PATT. NO. 444A327  
CASE PATT. NO.  
180A041 UPPER (ALL)  
180A044 LOWER (411)  
180A081 LOWER (412 & 413)  
MIN. IMP. DIA. 279 mm

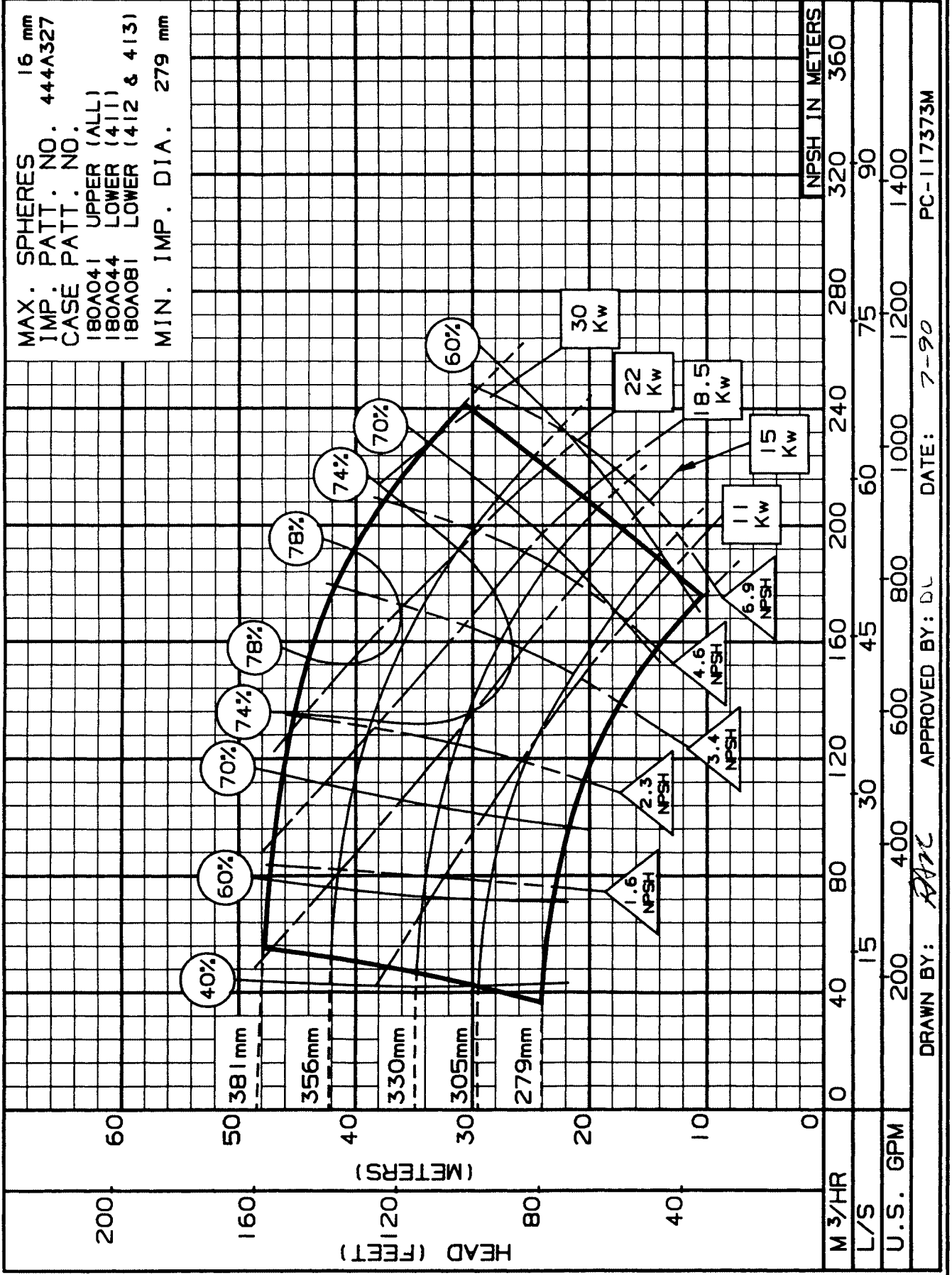

DRAWN BY: *APC* APPROVED BY: DL DATE: 7-90 PC-117373M

4x5x15 - 960 RPM  
 ENCLOSED IMPELLER

SIZE: 4X5X15 TYPE: 410 IMPELLER: ENCLOSED R.P.M.: 960

MAX. SPHERES 16 mm  
 IMP. PATT. NO. 444A327  
 CASE PATT. NO.  
 180A041 UPPER (ALL)  
 180A044 LOWER (411)  
 180A081 LOWER (412 & 413)  
 MIN. IMP. DIA. 279 mm

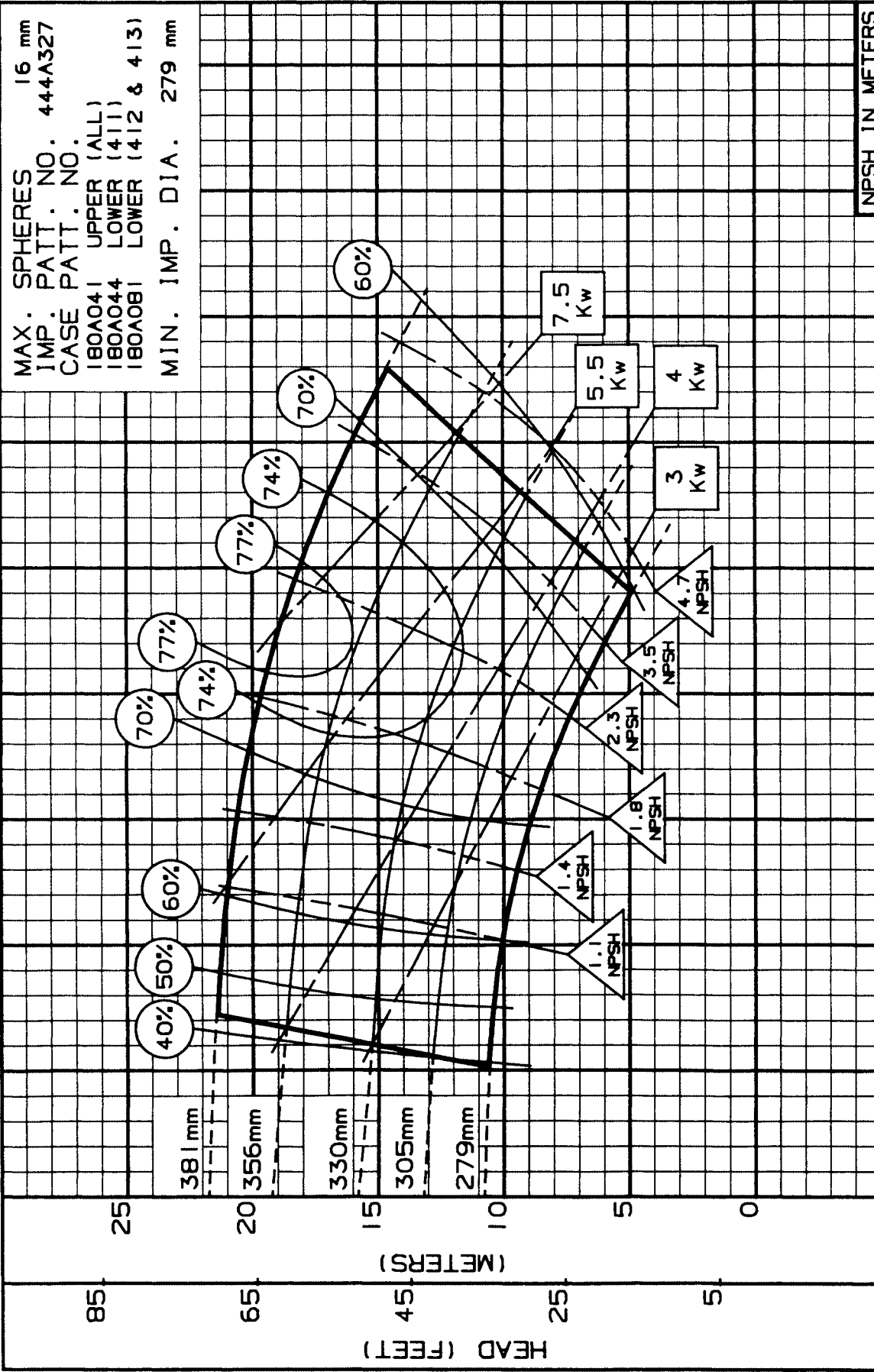

M <sup>3</sup> /HR	0	25	50	75	100	125	150	175	200	225
L/S	10	150	300	450	600	750	900			
U.S. GPM	150	300	450	600	750	900				
DRAWN BY: <i>APK</i> APPROVED BY: DL DATE: 7-90 PC-117374M										



SIZE: 4X6X18B TYPE: 410 IMPELLER: ENCLOSED R.P.M.: 1475

MAX. SPHERES 14 mm  
IMP. PATT. NO. 444A142  
CASE PATT. NO.  
180A215 UPPER (ALL)  
180A216 LOWER (411)  
180A259 LOWER (412 & 413)  
MIN. IMP. DIA. 394 mm

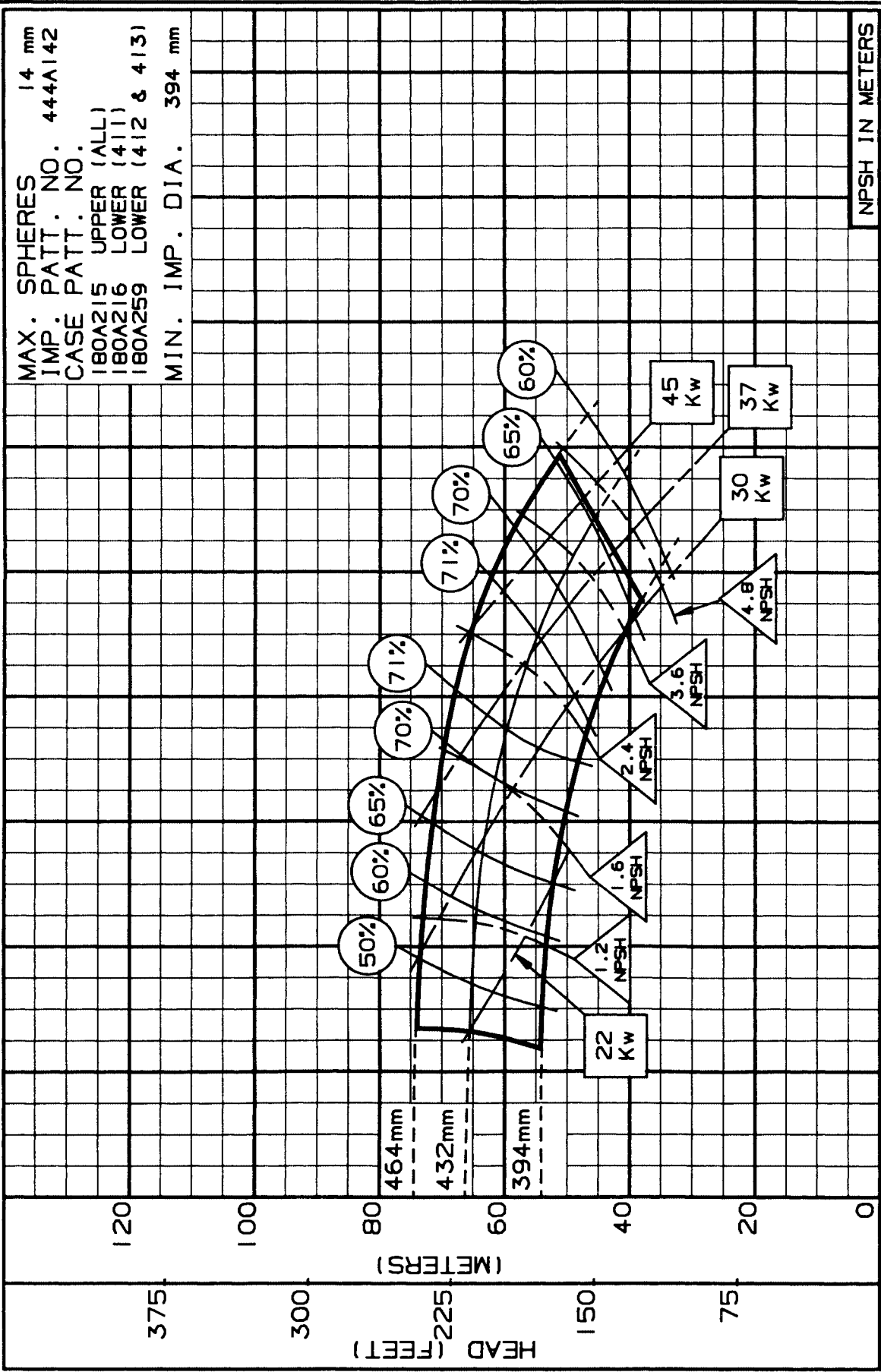

M <sup>3</sup> /HR	0	40	80	120	160	200	240	280	320	360
L/S	15	30	45	60	75	90	100	1200	1400	
U.S. GPM	200	400	600	800	1000	1200	1400			
DRAWN BY: <i>AKC</i> APPROVED BY: DL DATE: 7-90										
PC-117375M										

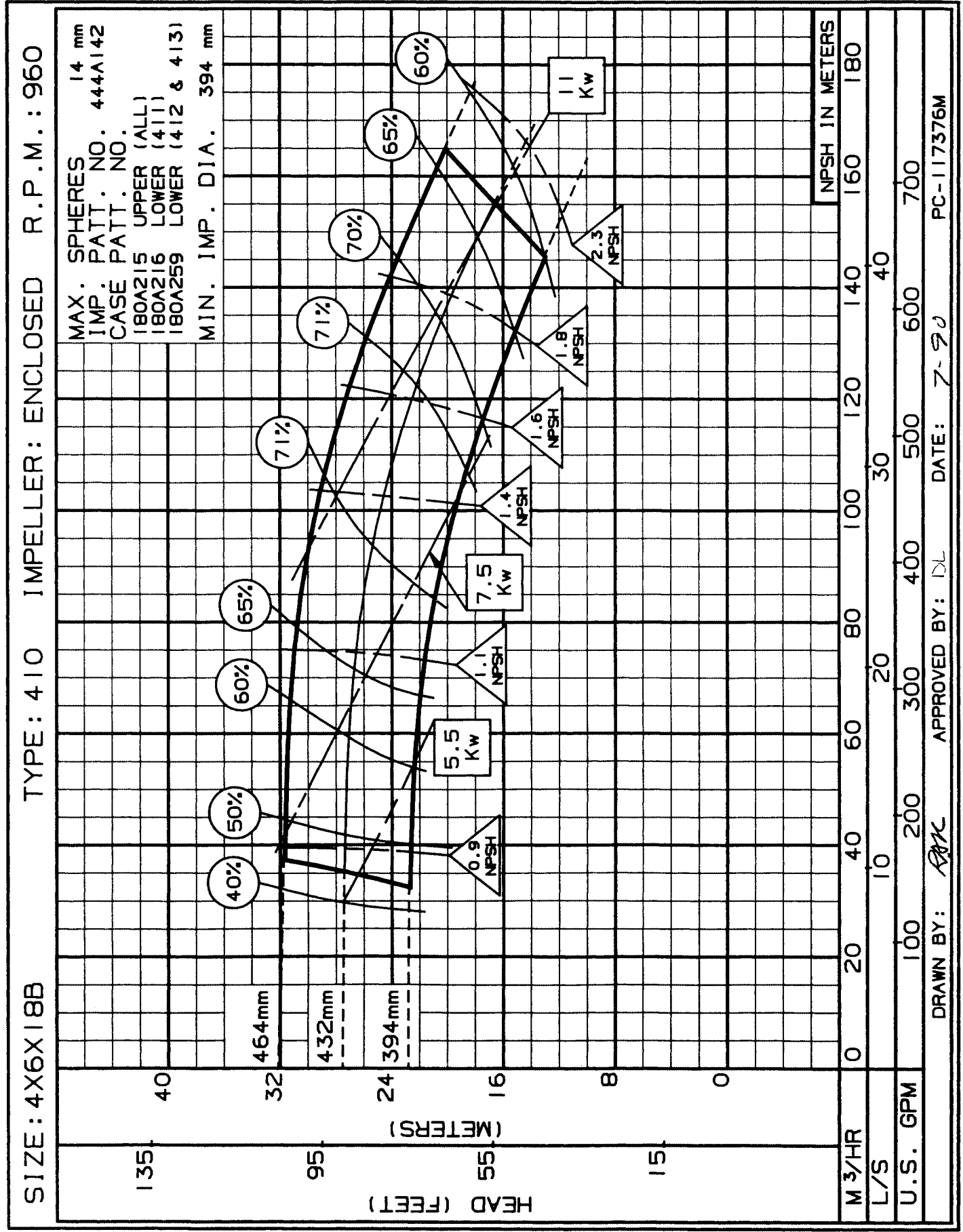

SIZE: 5X6X11A TYPE: 410 IMPELLER: ENCLOSED R.P.M.: 1440

MAX. SPHERES 25 mm  
IMP. PATT. NO. 444A325  
CASE PATT. NO.  
180A039 UPPER (ALL)  
180A040 LOWER (411)  
180A079 LOWER (412 & 413)  
MIN. IMP. DIA. 184 mm

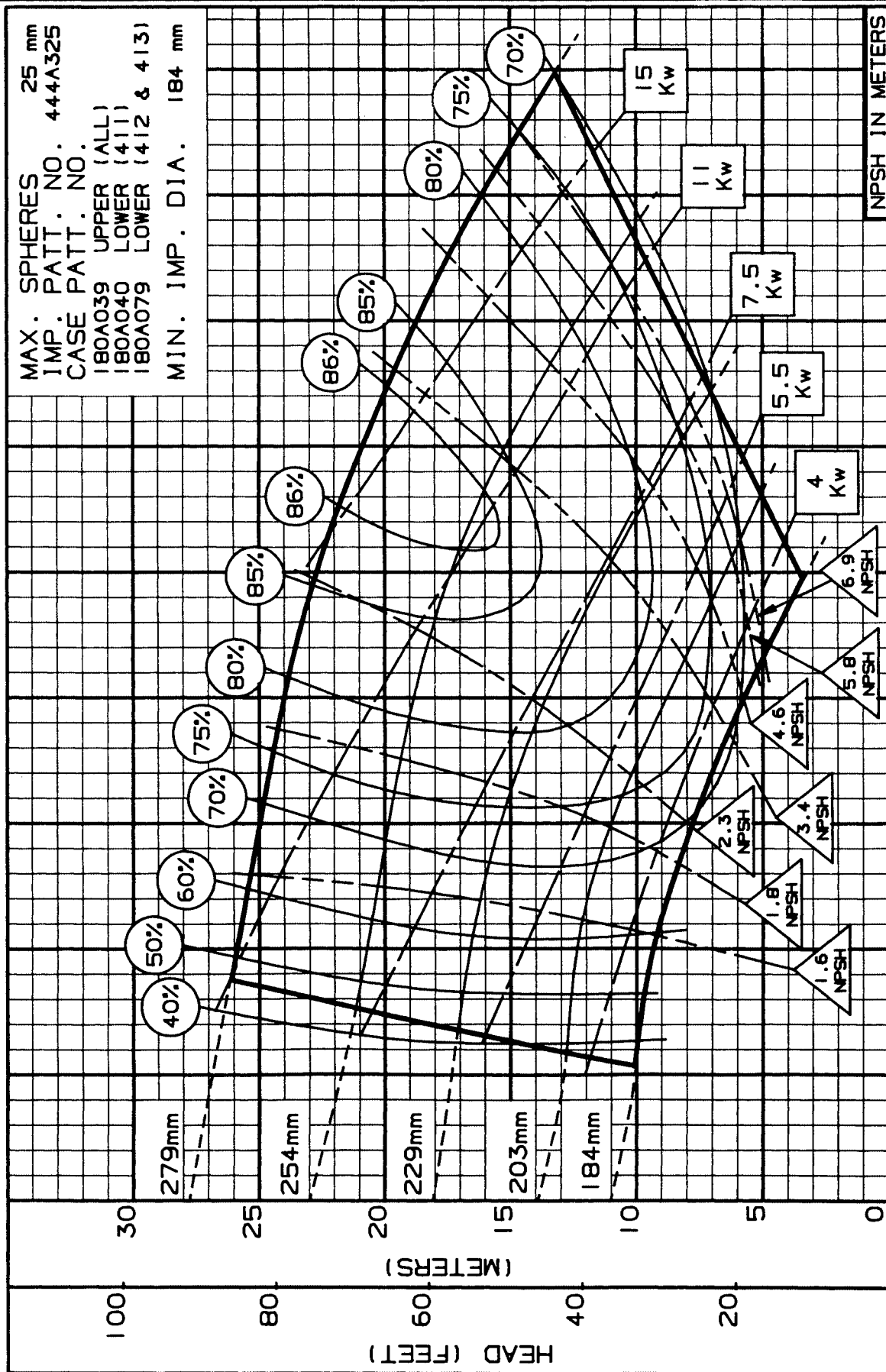

M <sup>3</sup> /HR	0	40	80	120	160	200	240	280	320	360
L/S	0	15	30	45	60	75	90	100	1200	1400
U.S. GPM	0	200	400	600	800	1000	1200	1400	1400	1400
DRAWN BY: <i>ATL</i> APPROVED BY: DL DATE: 7-90 PC-117377M										

5x6x11A - 960 RPM  
 ENCLOSED IMPELLER

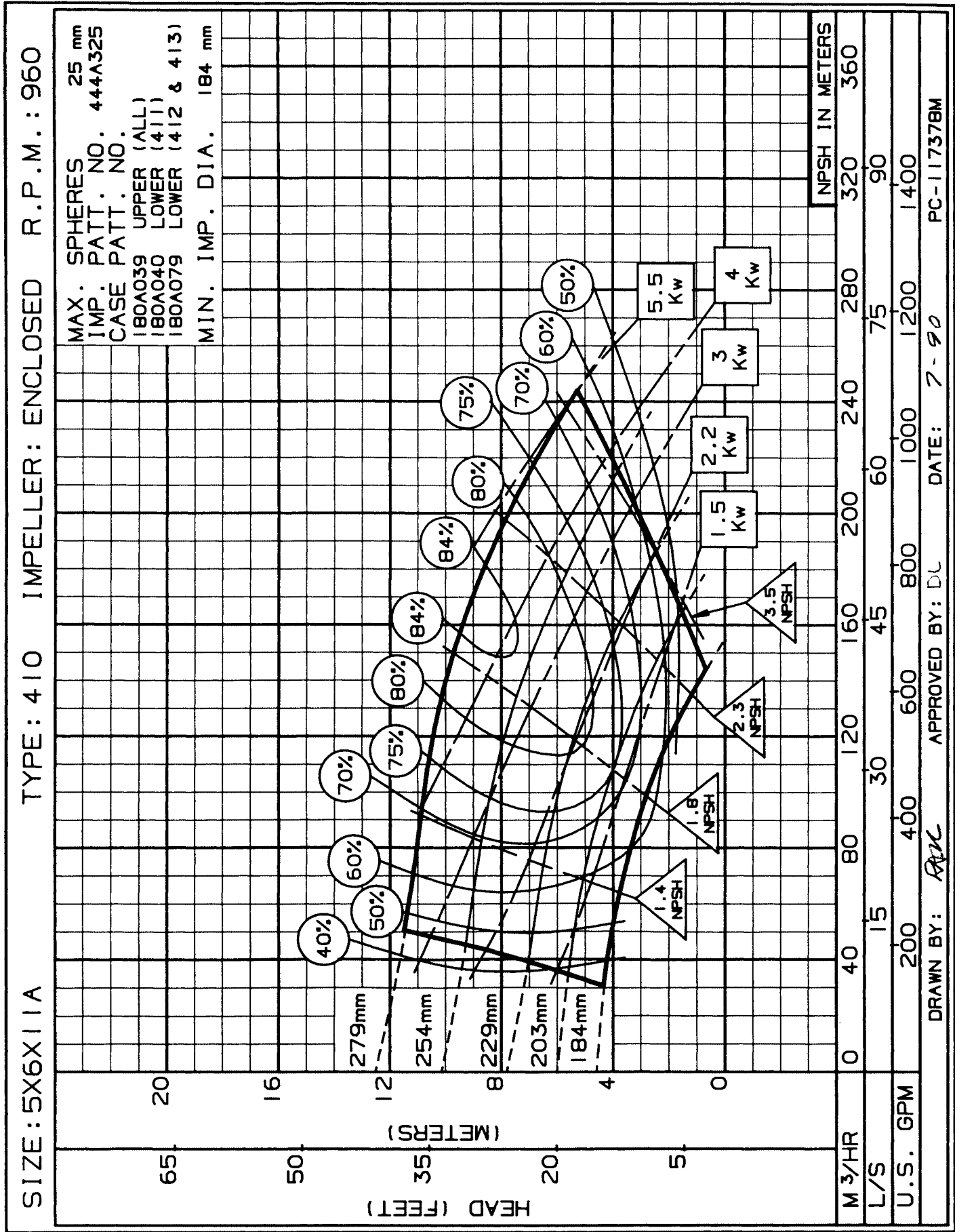

DRAWN BY: *APC* APPROVED BY: DC DATE: 7-90 PC-11737BM

SIZE: 5X6X11C TYPE: 410 IMPELLER: ENCLOSED R.P.M.: 2950

MAX. SPHERES 16 mm  
IMP. PATT. NO. 444A184  
CASE PATT. NO.  
180A263 UPPER (ALL)  
180A262 LOWER (411)  
180A264 LOWER (412 & 413)  
MIN. IMP. DIA. 191 mm

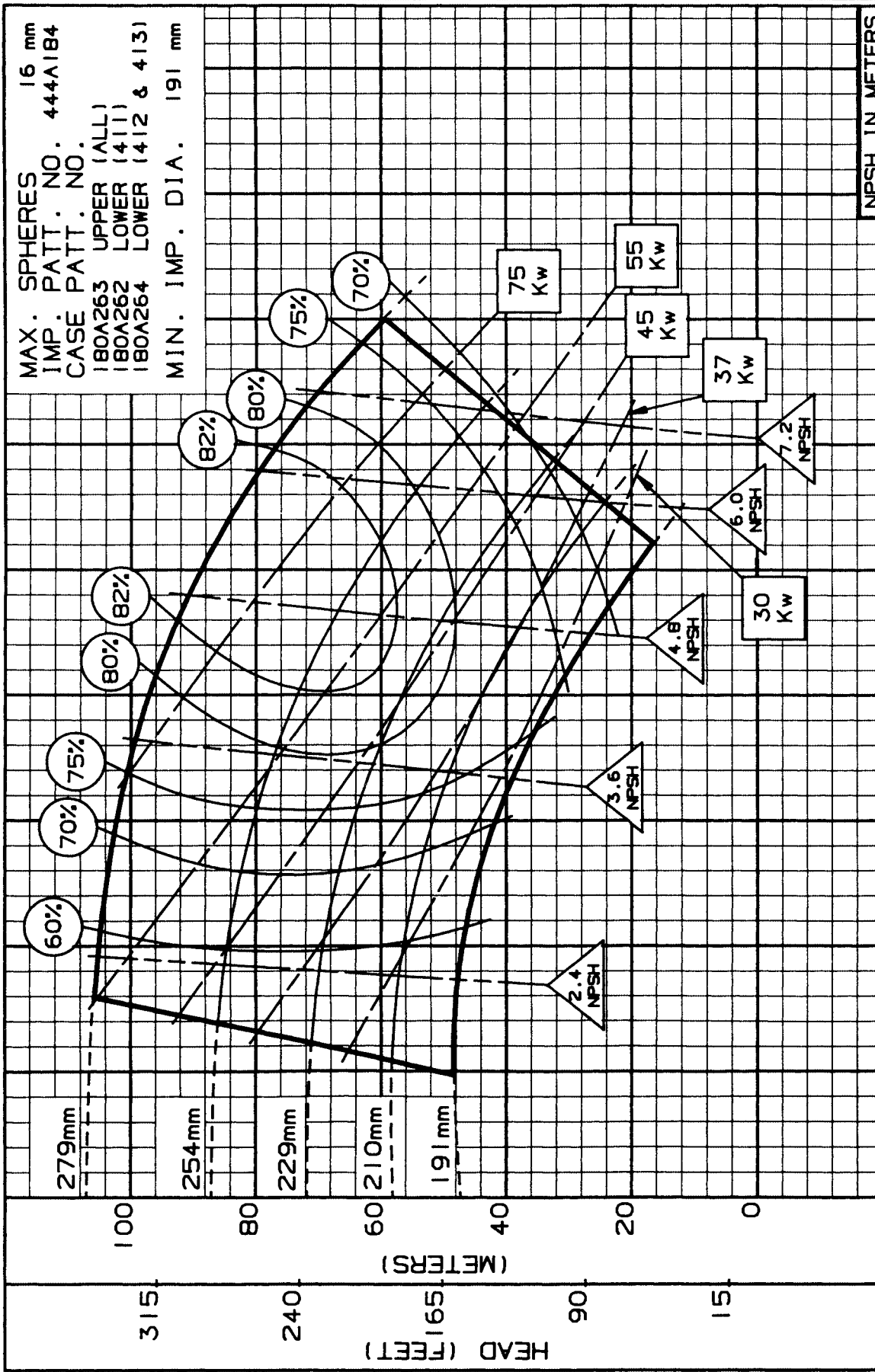

M <sup>3</sup> /HR	0	60	120	180	240	300	360	420	480	540
L/S	0	20	40	60	80	100	120	140	160	180
U.S. GPM	0	400	800	1200	1600	2000	2400	2800	3200	3600
NPSH IN METERS										

DRAWN BY: *AKC* APPROVED BY: DL DATE: 7-90 PC-125241M

# 5x6x11C - 1440 RPM

## ENCLOSED IMPELLER



Pentair Pump Group

SIZE: 5X6X11C TYPE: 410 IMPELLER: ENCLOSED R.P.M.: 1440

MAX. SPHERES 16 mm  
 IMP. PATT. NO. 444A184  
 CASE PATT. NO.  
 180A263 UPPER (ALL)  
 180A262 LOWER (411)  
 180A264 LOWER (412 & 413)  
 MIN. IMP. DIA. 191 mm

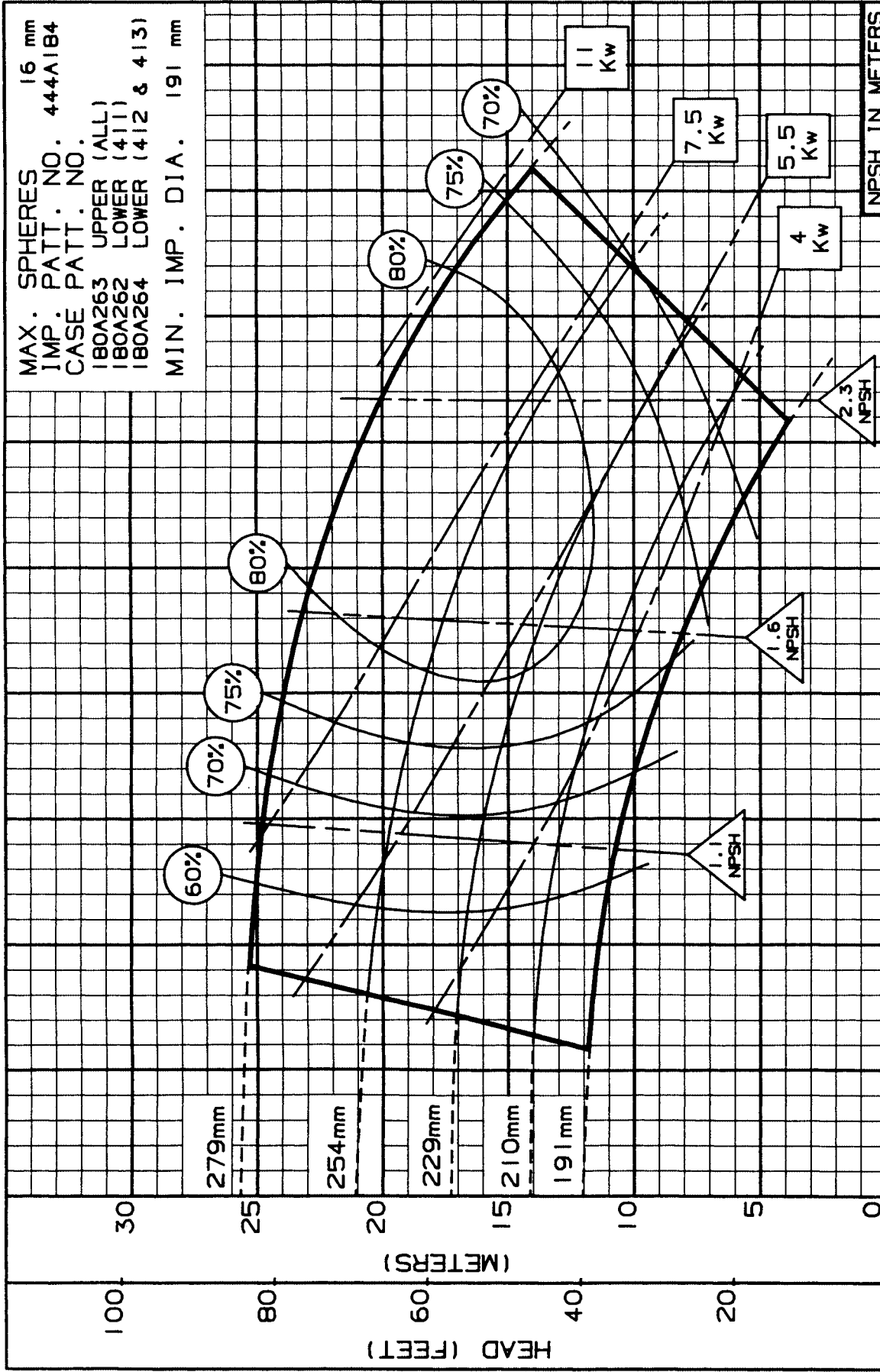

M <sup>3</sup> /HR	0	25	50	75	100	125	150	175	200	225
L/S	0	10	20	30	40	50	60	75	90	110
U.S. GPM	0	150	300	450	600	750	900	1050	1200	1350
NPSH IN METERS										
PC-125240M										

DRAWN BY: *RAK* APPROVED BY: DL DATE: 7-90

SIZE: 5X6X15 TYPE: 410 IMPELLER: ENCLOSED R.P.M.: 1440

MAX. SPHERES 21 mm  
IMP. PATT. NO. 444A328  
CASE PATT. NO.  
180A041 UPPER (ALL)  
180A042 LOWER (411)  
180A080 LOWER (412 & 413)  
MIN. IMP. DIA. 254 mm

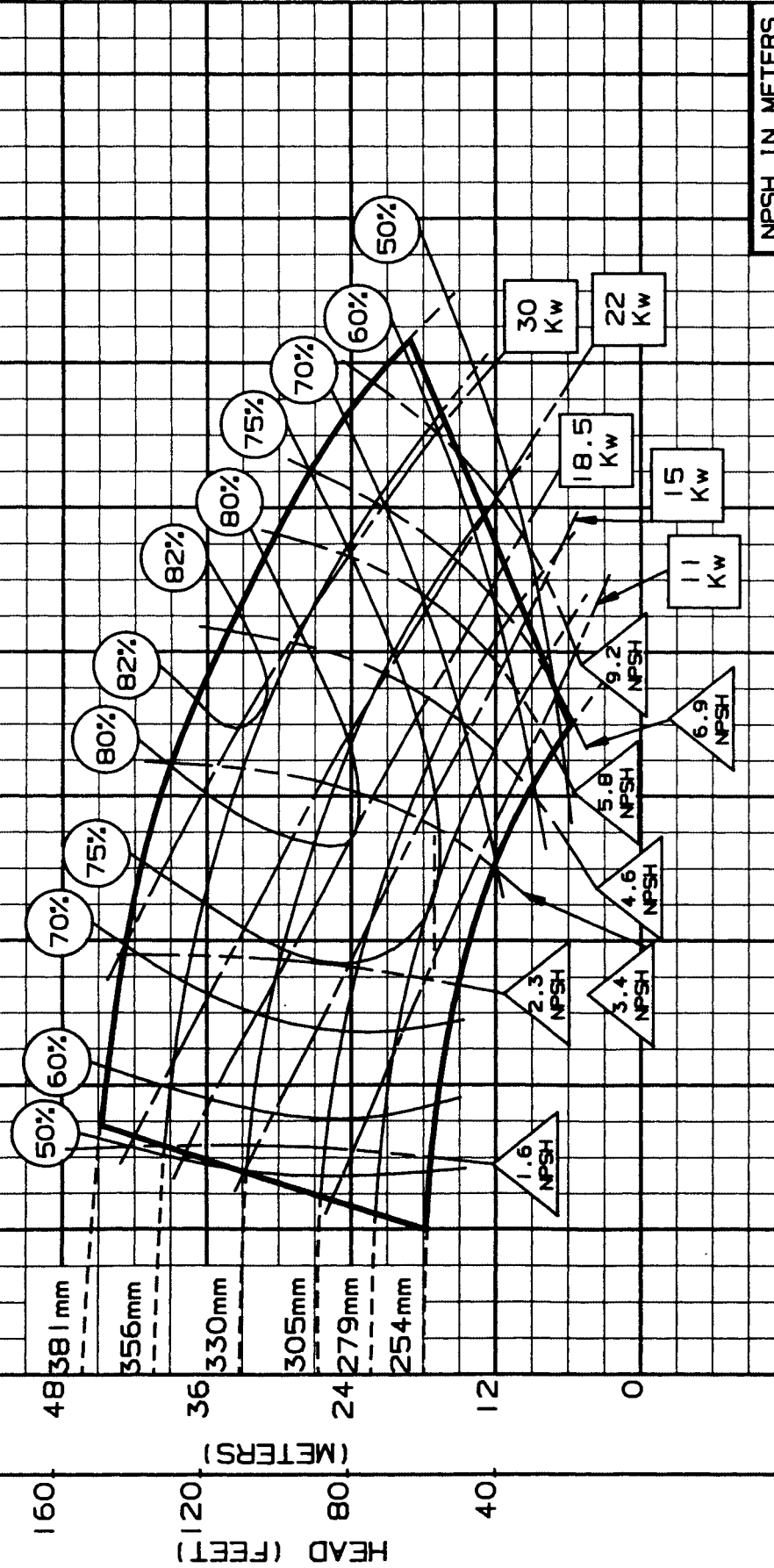

M <sup>3</sup> /HR	0	60	120	180	240	300	360	420	480	540
L/S	0	20	40	60	80	100	120	140	160	180
U.S. GPM	0	400	800	1200	1600	2000	2400	2800	3200	3600
NPSH IN METERS										

DRAWN BY: *RAC* APPROVED BY: DL DATE: 7-90 PC-117379M

SECTION 410 (Metric 50Hz)

DATE JULY 1994

SUPERCEDES MARCH 1986

# 5x6x15 - 960 RPM ENCLOSED IMPELLER



TYPE: 410 IMPELLER: ENCLOSED R.P.M.: 960

SIZE: 5X6X15

MAX. SPHERES 21 mm  
 IMP. PATT. NO. 444A328  
 CASE PATT. NO.  
 180A041 UPPER (ALL)  
 180A042 LOWER (411)  
 180A080 LOWER (412 & 413)  
 MIN. IMP. DIA. 254 mm

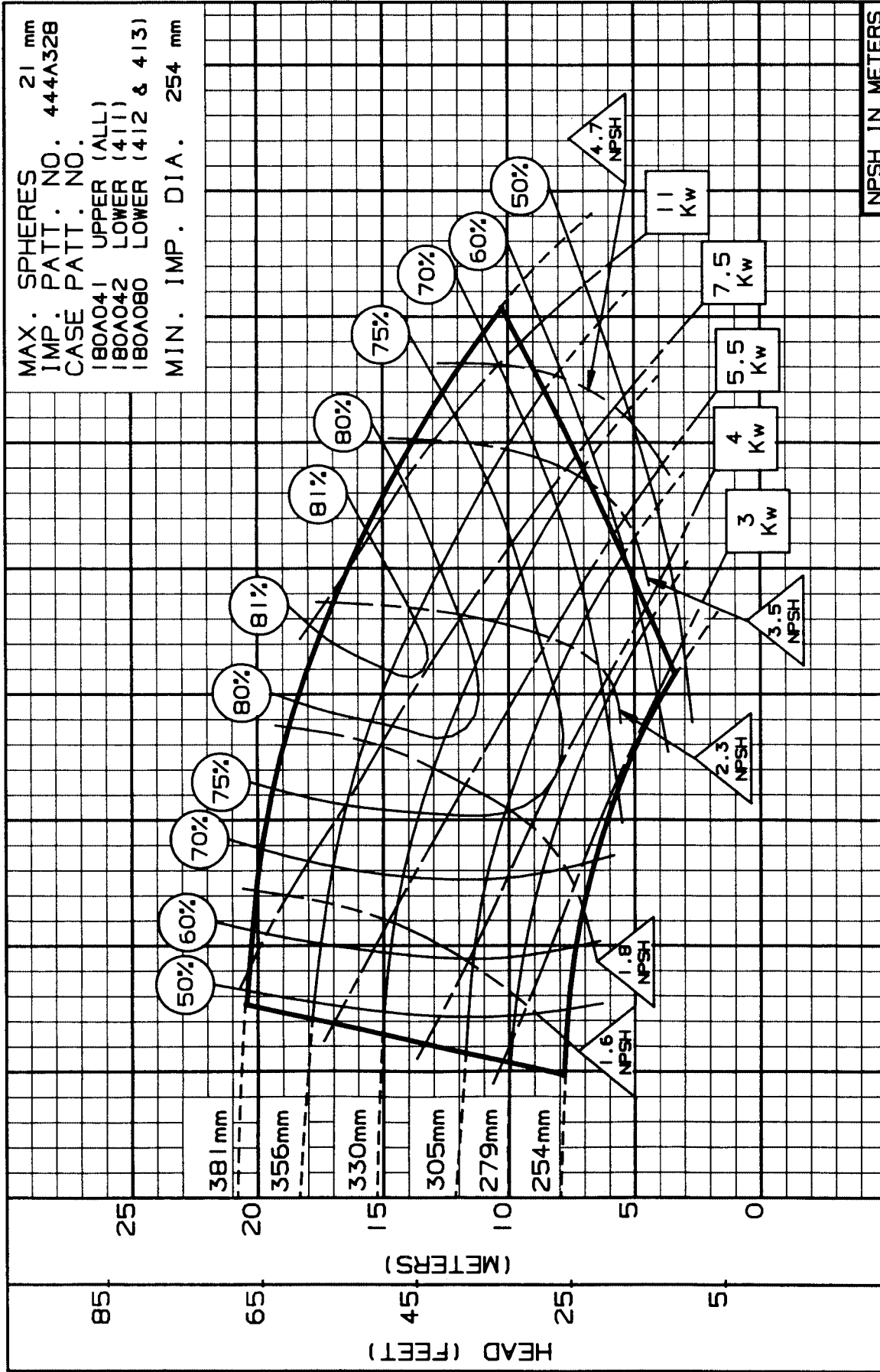

M <sup>3</sup> /HR	0	40	80	120	160	200	240	280	320	360
L/S	15	30	45	60	75	90	100	120	140	1400
U.S. GPM	200	400	600	800	1000	1200	1400			

DRAWN BY: *ATZ* APPROVED BY: DL DATE: 7-90 PC-117380M



SIZE: 5X6X17 TYPE: 410 IMPELLER: ENCLOSED R.P.M.: 1475

MAX. SPHERES 17 mm  
IMP. PATT. NO. 444A329  
CASE PATT. NO.  
180A041 UPPER (ALL)  
180A044 LOWER (411)  
180A081 LOWER (412 & 413)  
MIN. IMP. DIA. 330 mm

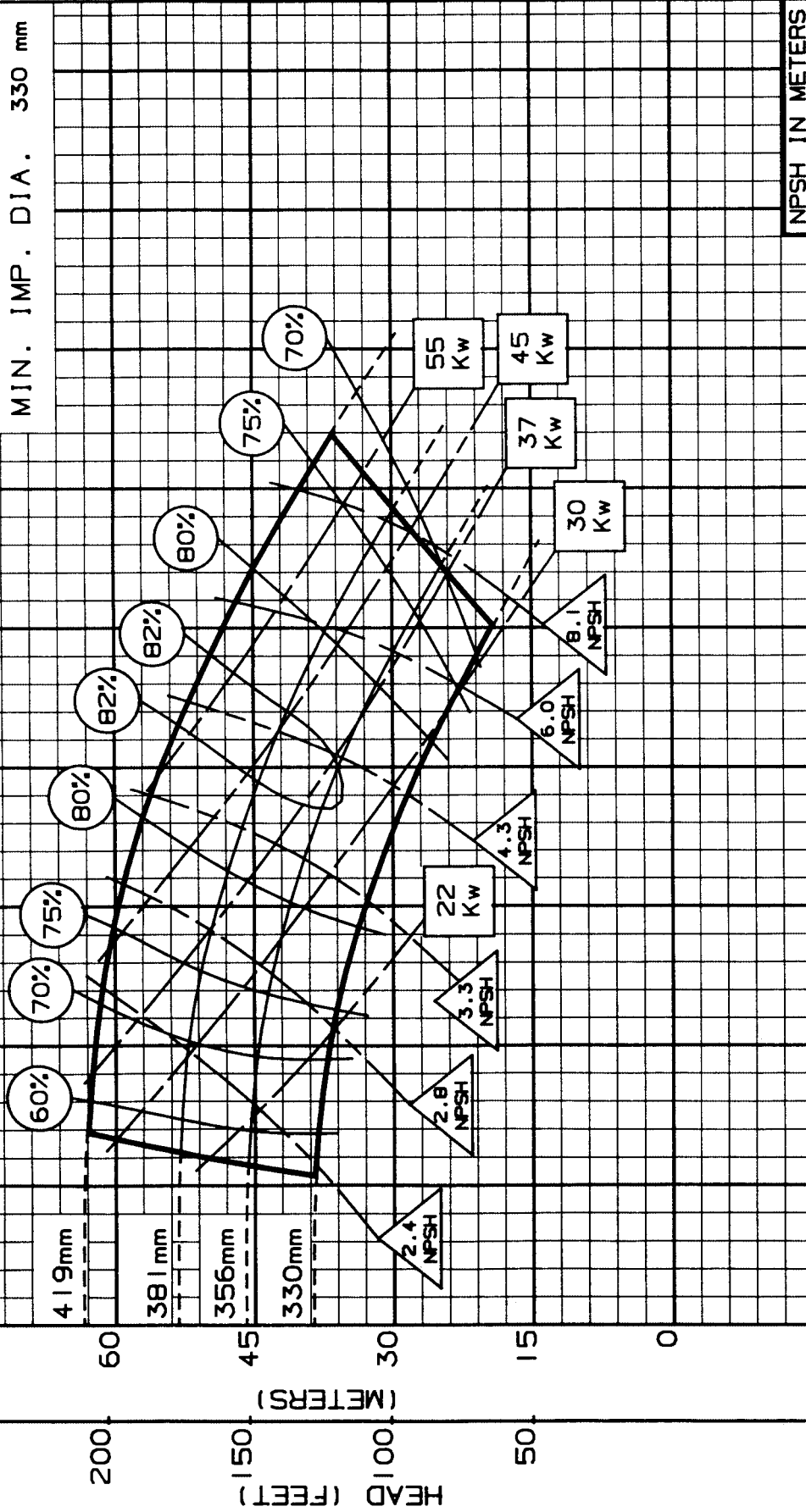

M <sup>3</sup> /HR	0	75	150	225	300	375	450	525	600	675
L/S	0	25	50	75	100	125	150	175	200	225
U.S. GPM	0	400	800	1200	1600	2000	2400	2800	3200	3600
NPSH IN METERS										
	0	75	150	225	300	375	450	525	600	675

DRAWN BY: *ATL* APPROVED BY: *DL* DATE: 7-90 PC-14478BM

5x6x17 - 960 RPM

ENCLOSED IMPELLER



Pentair Pump Group

SIZE: 5X6X17 TYPE: 410 IMPELLER: ENCLOSED R.P.M.: 960

MAX. SPHERES 17 mm  
 IMP. PATT. NO. 444A329  
 CASE PATT. NO.  
 180A041 UPPER (ALL)  
 180A044 LOWER (411)  
 180A081 LOWER (412 & 413)  
 MIN. IMP. DIA. 330 mm

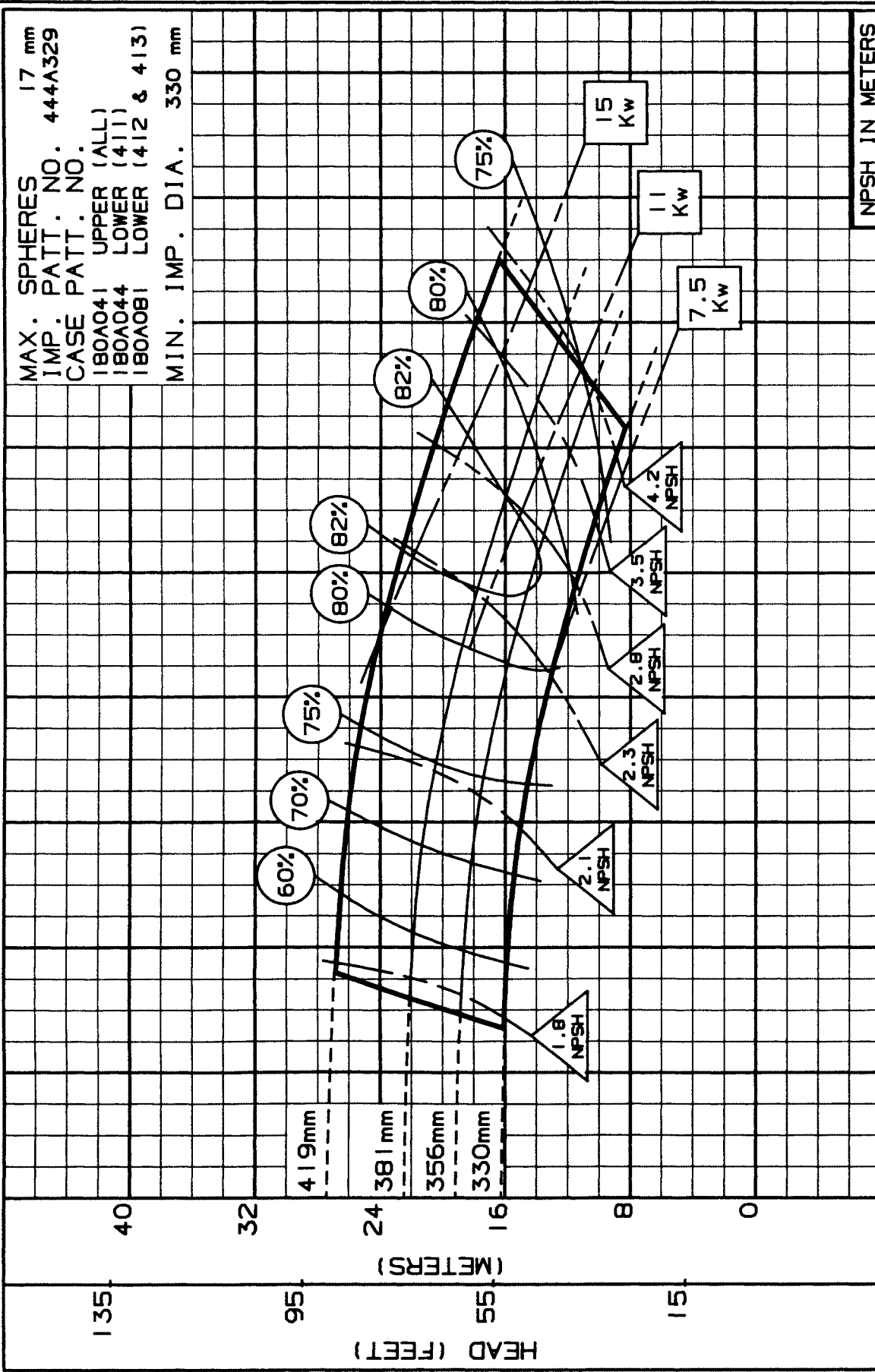

M <sup>3</sup> /HR	0	40	80	120	160	200	240	280	320	360
L/S	0	15	30	45	60	75	90	100	120	140
U.S. GPM	0	200	400	600	800	1000	1200	1400	1600	1800
NPSH IN METERS										

DRAWN BY: *SPZ* APPROVED BY: DL DATE: 7-90 PC-144789M

SIZE: 6X8X11 TYPE: 410 IMPELLER: ENCLOSED R.P.M.: 1440

MAX. SPHERES 25 mm  
IMP. PATT. NO. 444A327  
CASE PATT. NO.  
180A045 UPPER (ALL)  
180A046 LOWER (411)  
180A082 LOWER (412 & 413)  
MIN. IMP. DIA. 184 mm

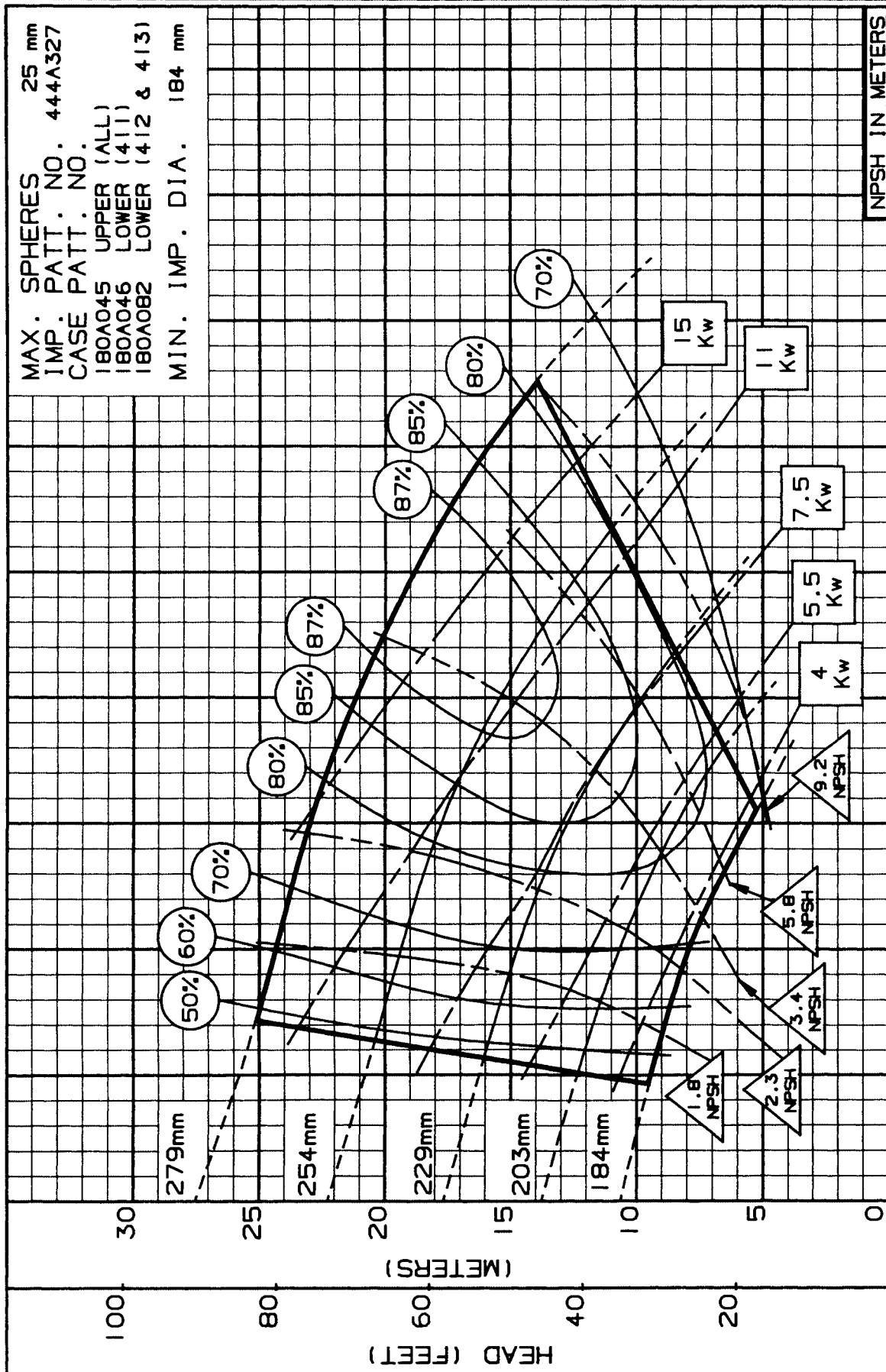

M <sup>3</sup> /HR	0	60	120	180	240	300	360	420	480	540
L/S	0	20	40	60	80	100	120	140	160	180
U.S. GPM	0	400	800	1200	1600	2000	2400	2800	3200	3600
NPSH IN METERS										

DRAWN BY: *RAZ* APPROVED BY: *DL* DATE: 7-90 PC-117383M

6x8x11- 960 RPM  
 ENCLOSED IMPELLER



SIZE: 6X8X11 TYPE: 410 IMPELLER: ENCLOSED R.P.M.: 960

MAX. SPHERES 25 mm  
 IMP. PATT. NO. 444A327  
 CASE PATT. NO.  
 180A045 UPPER (ALL)  
 180A046 LOWER (411)  
 180A082 LOWER (412 & 413)  
 MIN. IMP. DIA. 184 mm

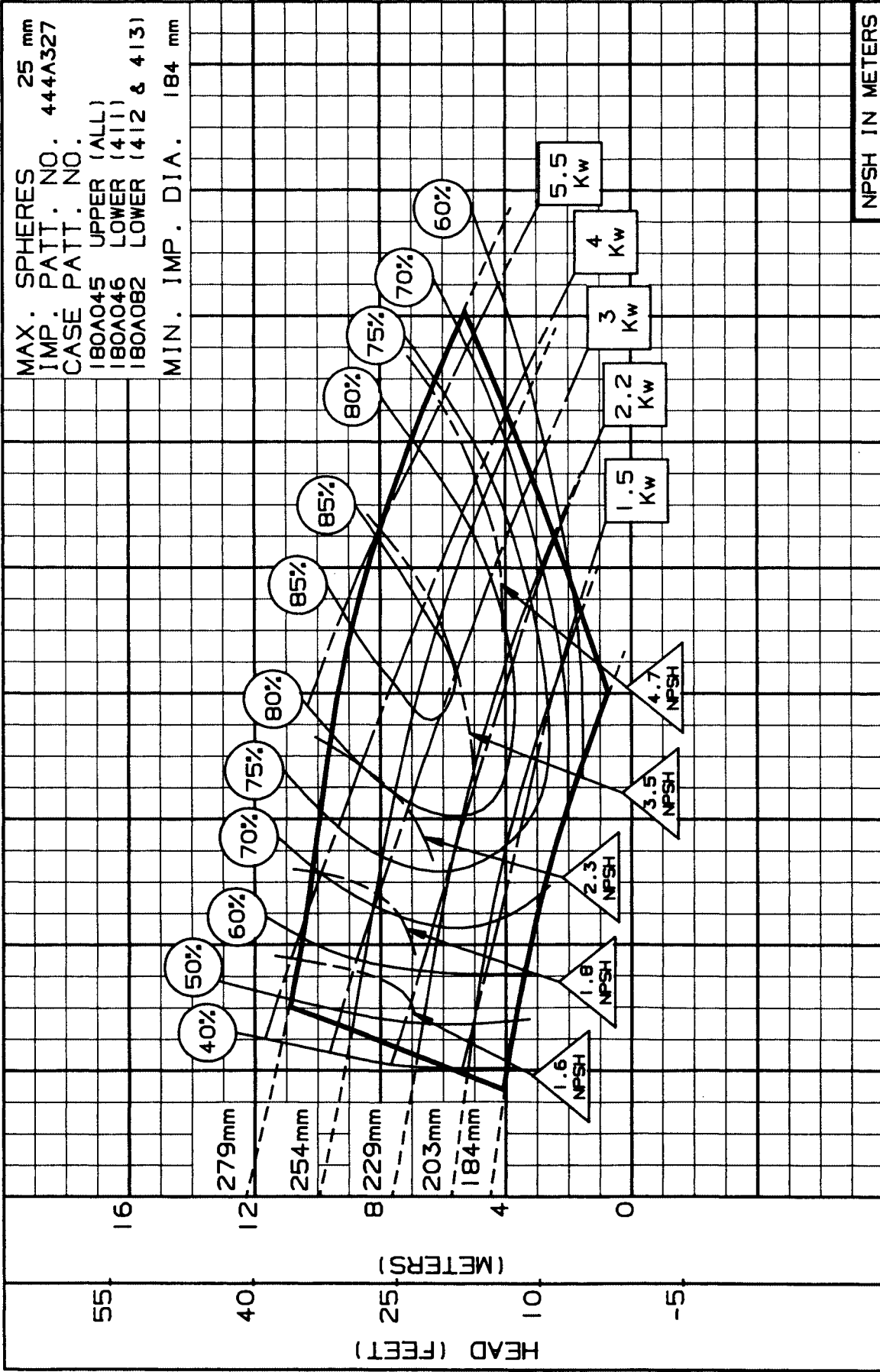

M <sup>3</sup> /HR	0	40	80	120	160	200	240	280	320	360
L/S	15	30	45	60	75	90	100	1200	1400	
U.S. GPM	200	400	600	800	1000	1200	1400			
DRAWN BY: <i>PAK</i> APPROVED BY: DL DATE: 7-90 PC-117384M										

SIZE: 6X8X15 TYPE: 410 IMPELLER: ENCLOSED R.P.M.: 1475

MAX. SPHERES 24 mm  
IMP. PATT. NO. 444A330  
CASE PATT. NO.  
180A047 UPPER (ALL)  
180A048 LOWER (411)  
180A083 LOWER (412 & 413)  
MIN. IMP. DIA. 254 mm

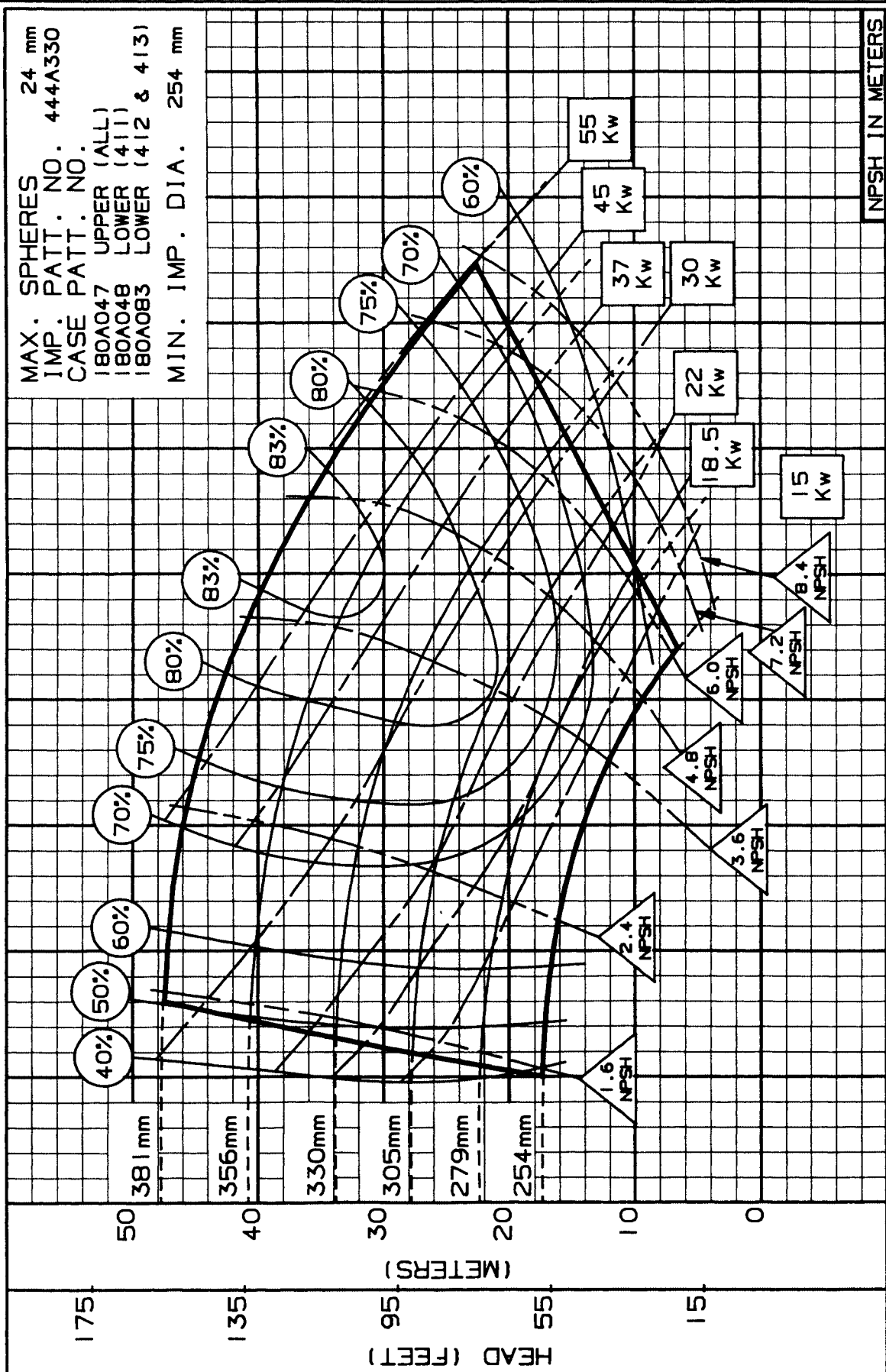

M <sup>3</sup> /HR	0	80	160	240	320	400	480	560	640	720
L/S	25	400	800	1200	1600	2000	2400	2800	3200	3600
U.S. GPM	400	800	1200	1600	2000	2400	2800	3200	3600	4000
NPSH IN METERS										

DRAWN BY: *RAC* APPROVED BY: *DL* DATE: 7-90 PC-117385M

6x8x15 - 960 RPM  
 ENCLOSED IMPELLER

SIZE: 6X8X15 TYPE: 410 IMPELLER: ENCLOSED R.P.M.: 960

MAX. SPHERES 24 mm  
 IMP. PATT. NO. 444A330  
 CASE PATT. NO.  
 180A047 UPPER (ALL)  
 180A048 LOWER (411)  
 180A083 LOWER (412 & 413)  
 MIN. IMP. DIA. 254 mm

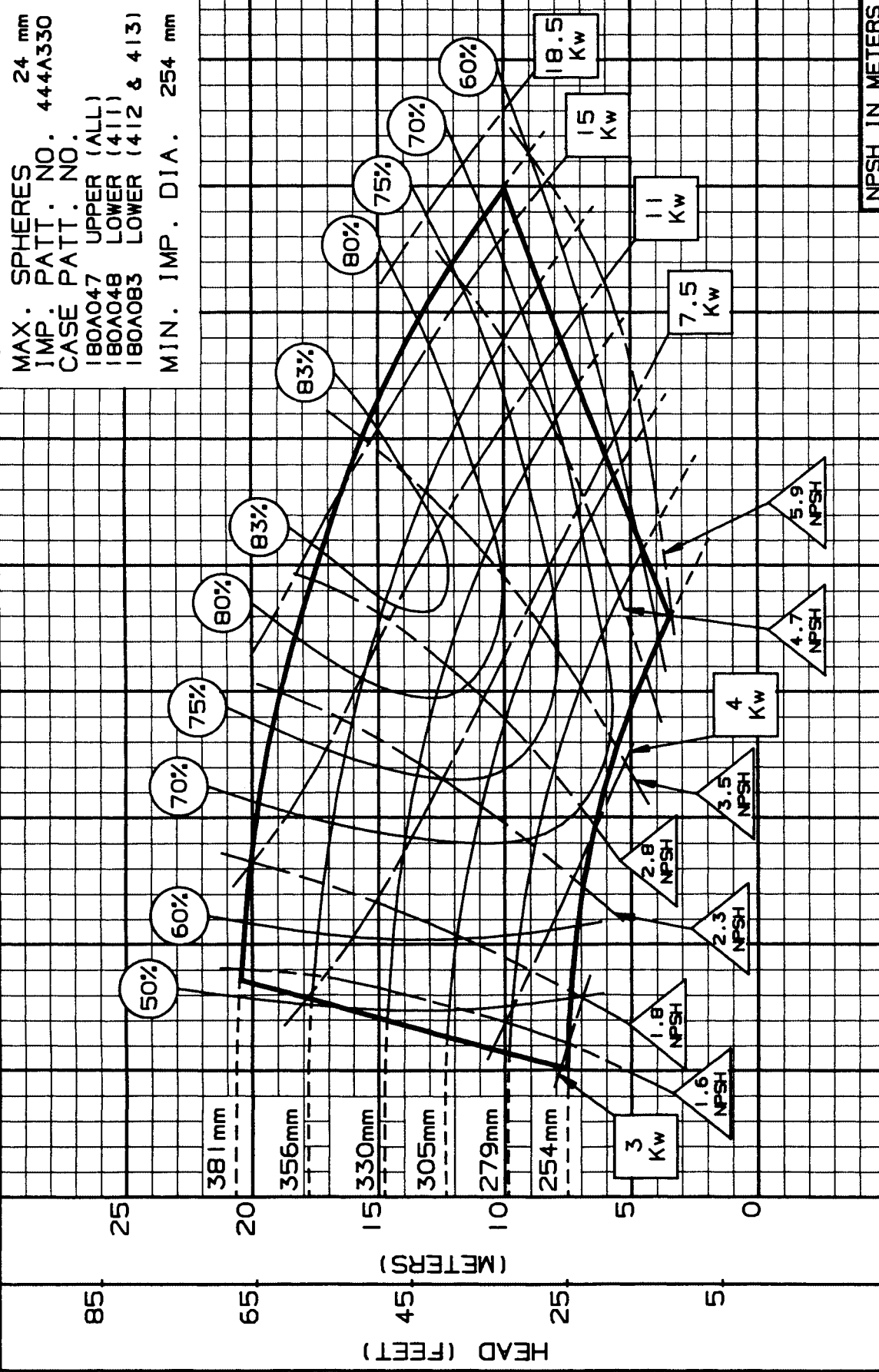

M <sup>3</sup> /HR	0	50	100	150	200	250	300	350	400	450
L/S	0	15	30	45	60	75	90	105	120	135
U.S. GPM	0	250	500	750	1000	1250	1500	1750	2000	2250

NPSH IN METERS

DRAWN BY: *RAK* APPROVED BY: *DL* DATE: 7-90 PC-117386M

SIZE: 6X8X18A TYPE: 410 IMPELLER: ENCLOSED R.P.M.: 1475

MAX. SPHERES 25 mm  
IMP. PATT. NO. 444A143  
CASE PATT. NO.  
180A217 UPPER (ALL)  
180A218 LOWER (411)  
180A260 LOWER (412 & 413)  
MIN. IMP. DIA. 368 mm

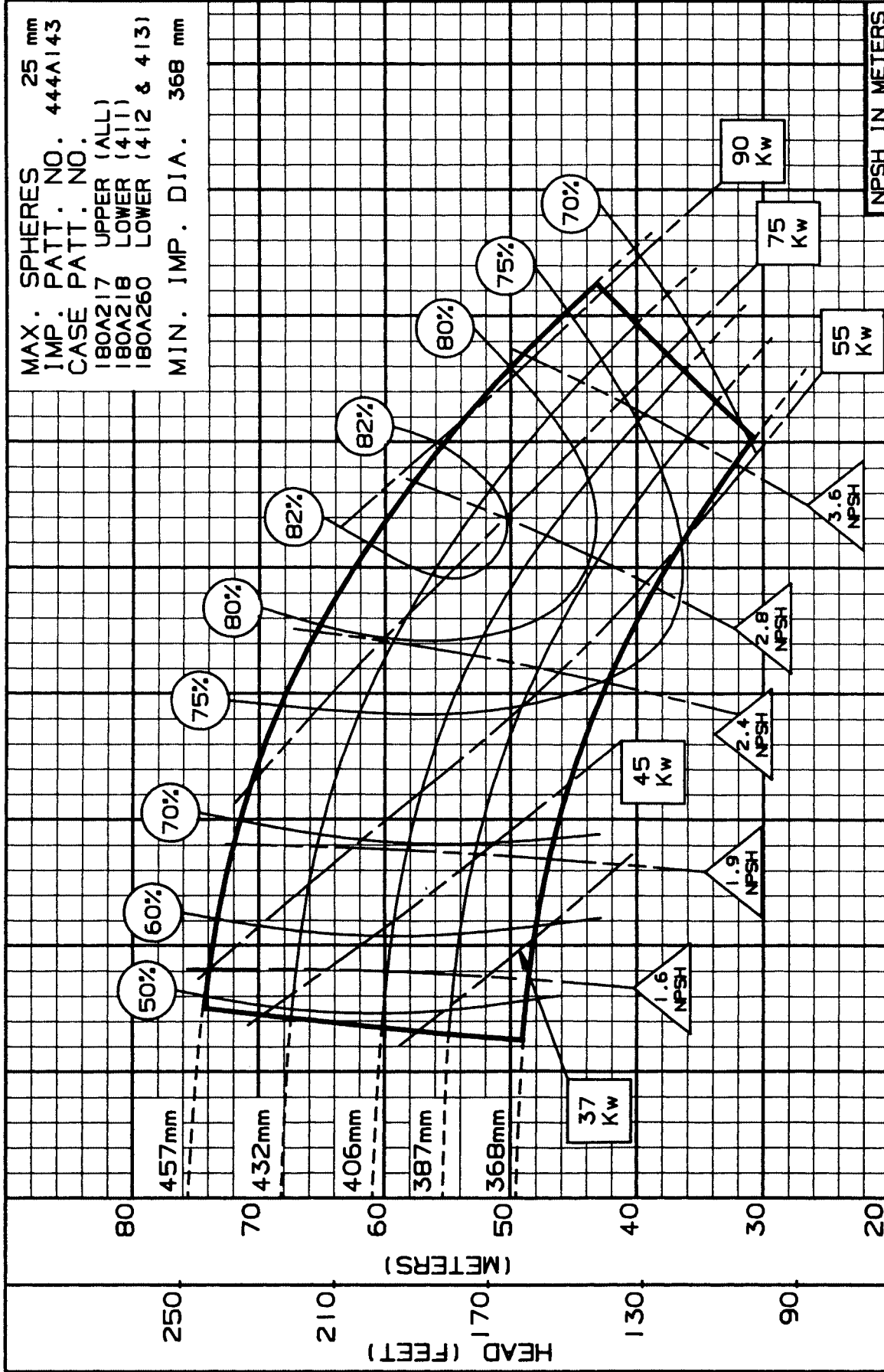

M <sup>3</sup> /HR	0	80	160	240	320	400	480	560	640	720
L/S	25	50	75	100	125	150	175	200	225	250
U.S. GPM	400	800	1200	1600	2000	2400	2800	3200	3600	4000
NPSH IN METERS										

DRAWN BY: *AMC* APPROVED BY: DL DATE: 7-90 PC-125666M

6x8x18A - 980 RPM  
 ENCLOSED IMPELLER



SIZE: 6X8X18A TYPE: 410 IMPELLER: ENCLOSED R.P.M.: 980

MAX. SPHERES 25 mm  
 IMP. PATT. NO. 444A143  
 CASE PATT. NO.  
 180A217 UPPER (ALL)  
 180A218 LOWER (411)  
 180A260 LOWER (412 & 413)  
 MIN. IMP. DIA. 368 mm

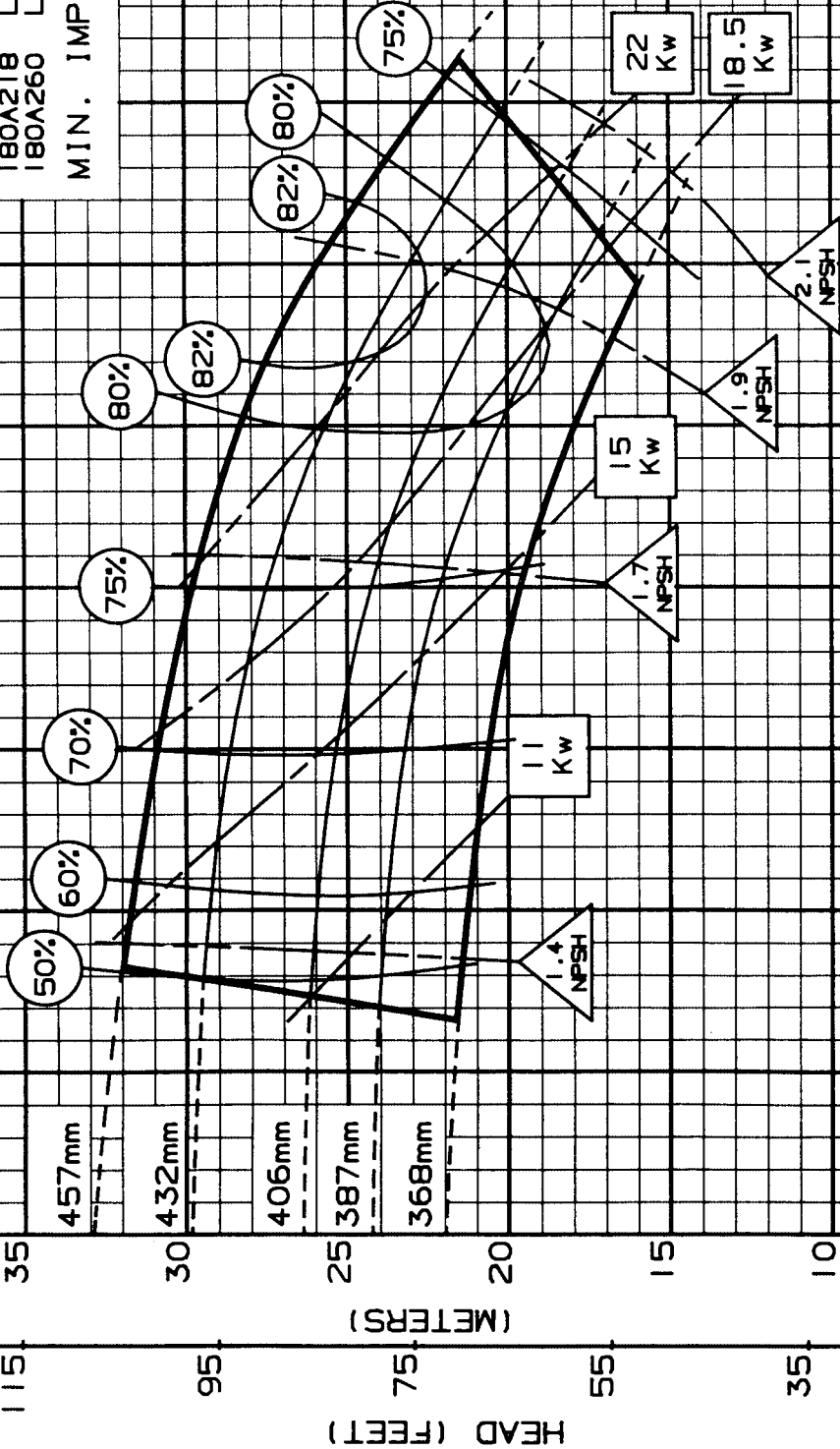

M <sup>3</sup> /HR	0	50	100	150	200	250	300	350	400	450
L/S		15	30	45	60	75	90	105	120	
U.S. GPM		250	500	750	1000	1250	1500	1750		
NPSH IN METERS										

DRAWN BY: *SK* APPROVED BY: DL DATE: 7-90 PC-125667M



SIZE: 6X8X18B TYPE: 410 IMPELLER: ENCLOSED R.P.M.: 1475

MAX. SPHERES 25 mm  
IMP. PATT. NO. 444A181  
CASE PATT. NO.  
180A217 UPPER (ALL)  
180A218 LOWER (411)  
180A260 LOWER (412 & 413)  
MIN. IMP. DIA. 394 mm

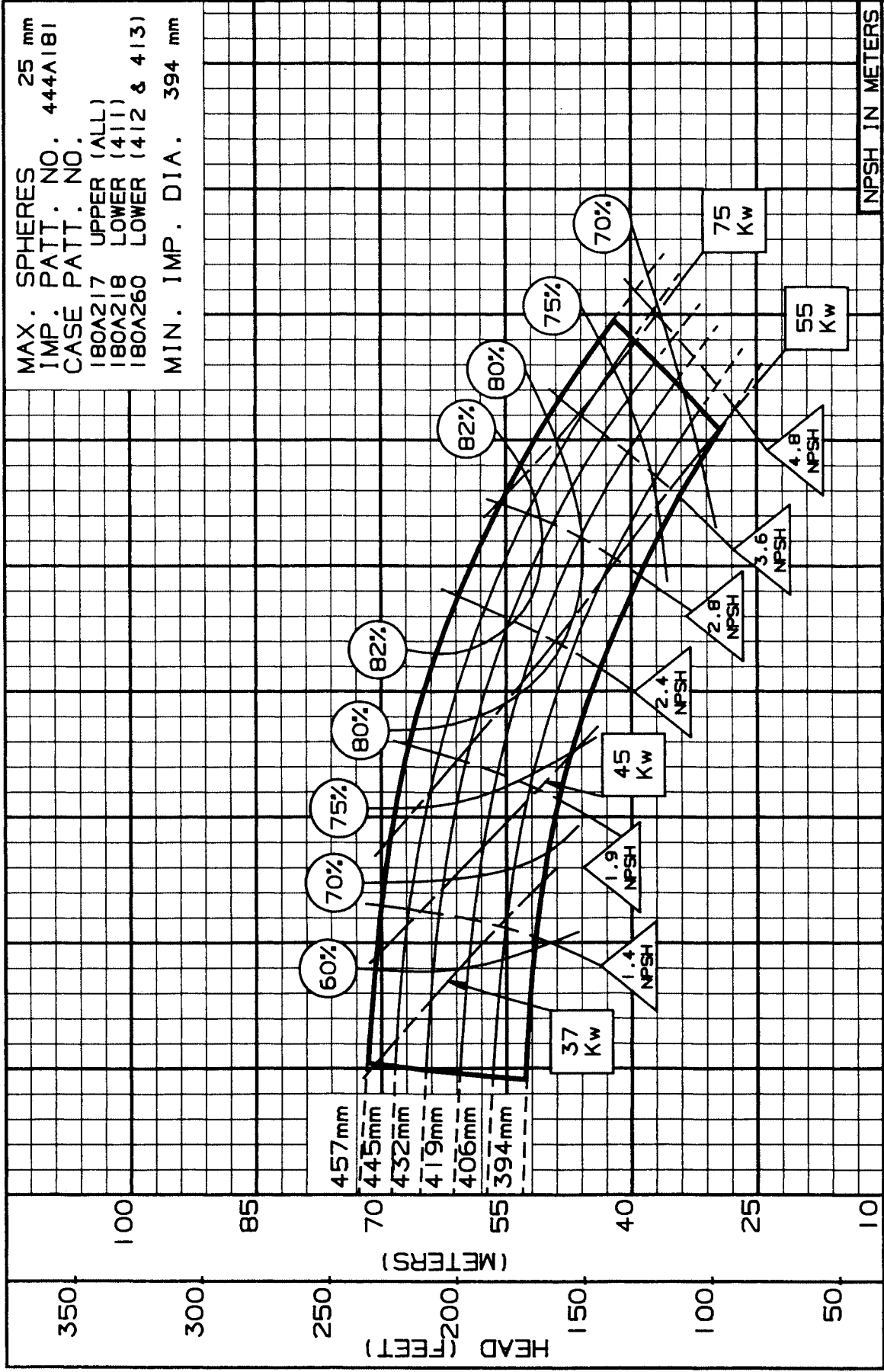

HEAD (FEET)	350	300	250	200	150	100	50			
HEAD (METERS)	100	85	70	55	40	25	10			
M ³/Hr	0	75	150	225	300	375	450	525	600	675
L/S	0	25	50	75	100	125	150	175	200	225
U.S. GPM	0	400	800	1200	1600	2000	2400	2800	3200	3600
NPSH IN METERS										
DRAWN BY: <i>AMC</i> APPROVED BY: <i>DL</i> DATE: 7-90 PC-125668M										

SIZE: 6X8X18B TYPE: 410 IMPELLER: ENCLOSED R.P.M.: 960

MAX. SPHERES 25 mm  
 IMP. PATT. NO. 444A181  
 CASE PATT. NO.  
 180A217 UPPER (ALL)  
 180A218 LOWER (411)  
 180A260 LOWER (412 & 413)  
 MIN. IMP. DIA. 394 mm

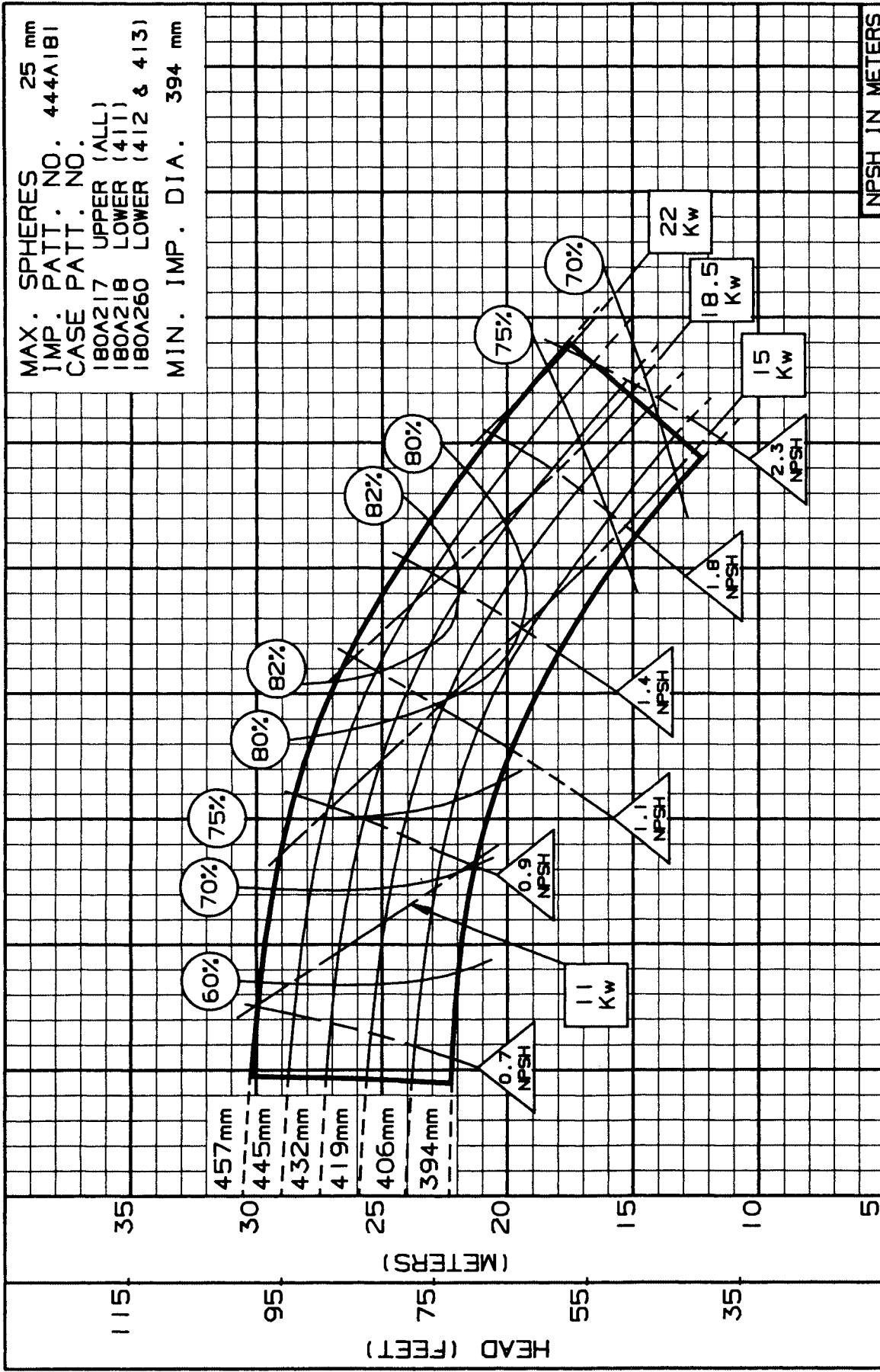

M <sup>3</sup> /HR	0	50	100	150	200	250	300	350	400	450
L/S	0	15	30	45	60	75	90	105	120	120
U.S. GPM	250	500	750	1000	1250	1500	1750	1750	1750	1750
NPSH IN METERS										

DRAWN BY: *RAZ* APPROVED BY: *DL* DATE: 7-90 PC-125669M

SIZE: 6X8X18C TYPE: 410 IMPELLER: ENCLOSED R.P.M.: 1475

MAX. SPHERES 25 mm  
IMP. PATT. NO. 444A183  
CASE PATT. NO.  
180A217 UPPER (ALL)  
180A218 LOWER (411)  
180A260 LOWER (412 & 413)  
MIN. IMP. DIA. 394 mm

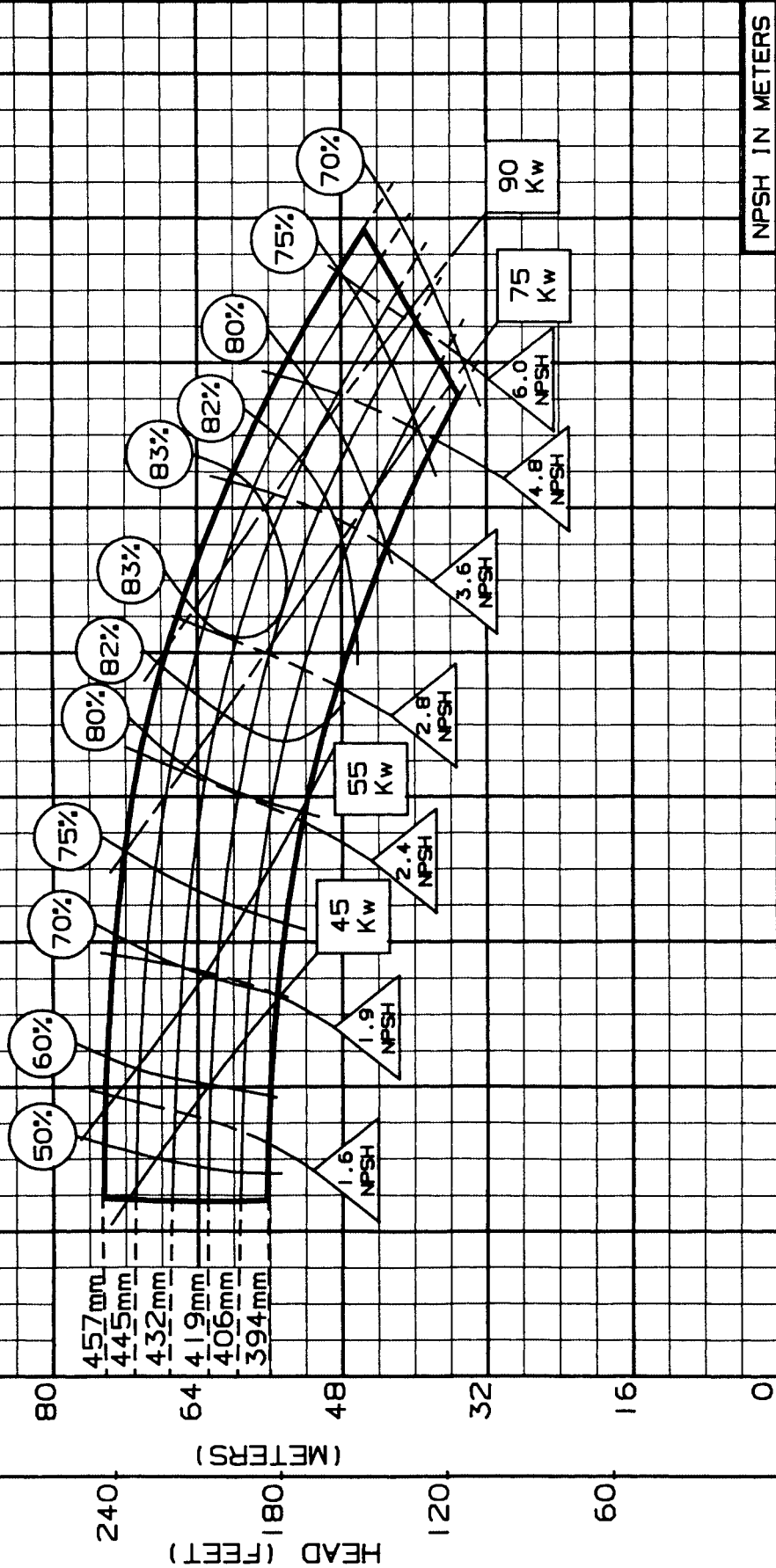

M <sup>3</sup> /HR	0	80	160	240	320	400	480	560	640	720
L/S	25	50	75	100	125	150	175	200	240	280
U.S. GPM	400	800	1200	1600	2000	2400	2800	3200	3600	4000
NPSH IN METERS										

DRAWN BY: *RAC* APPROVED BY: *DL* DATE: 7-90 PC-125670M

6x8x18C - 960 RPM  
 ENCLOSED IMPELLER



SIZE: 6X8X18C TYPE: 410 IMPELLER: ENCLOSED R.P.M.: 960

MAX. SPHERES 25 mm  
 IMP. PATT. NO. 444A183  
 CASE PATT. NO.  
 180A217 UPPER (ALL)  
 180A218 LOWER (411)  
 180A260 LOWER (412 & 413)  
 MIN. IMP. DIA. 394 mm

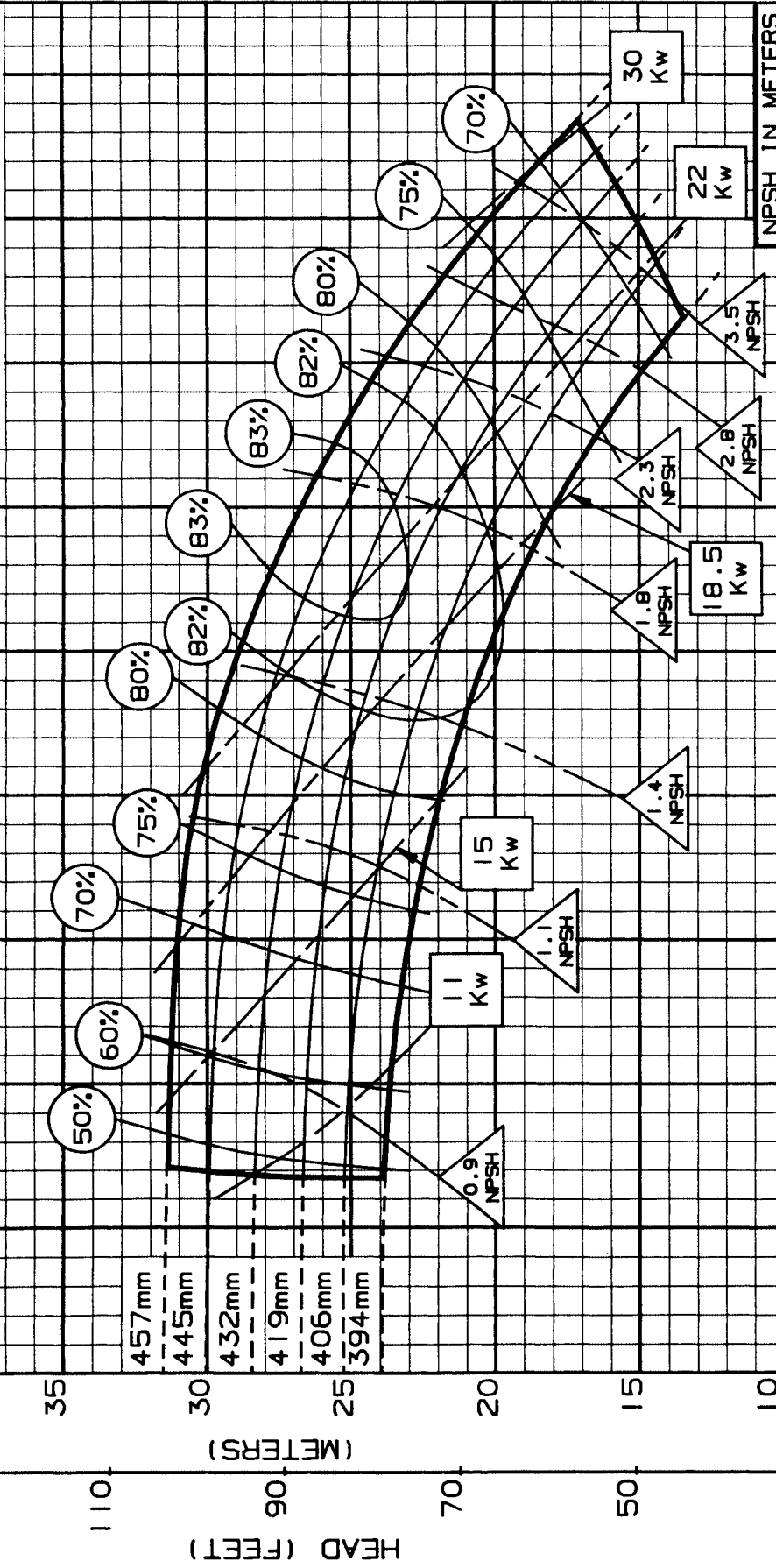

M <sup>3</sup> /HR	0	50	100	150	200	250	300	350	400	450
L/S		15	30	45	60	75	90	105	120	
U.S. GPM		250	500	750	1000	1250	1500	1750		
NPSH IN METERS										
DRAWN BY: <i>RAK</i> APPROVED BY: DL DATE: 7-90 PC-125671M										

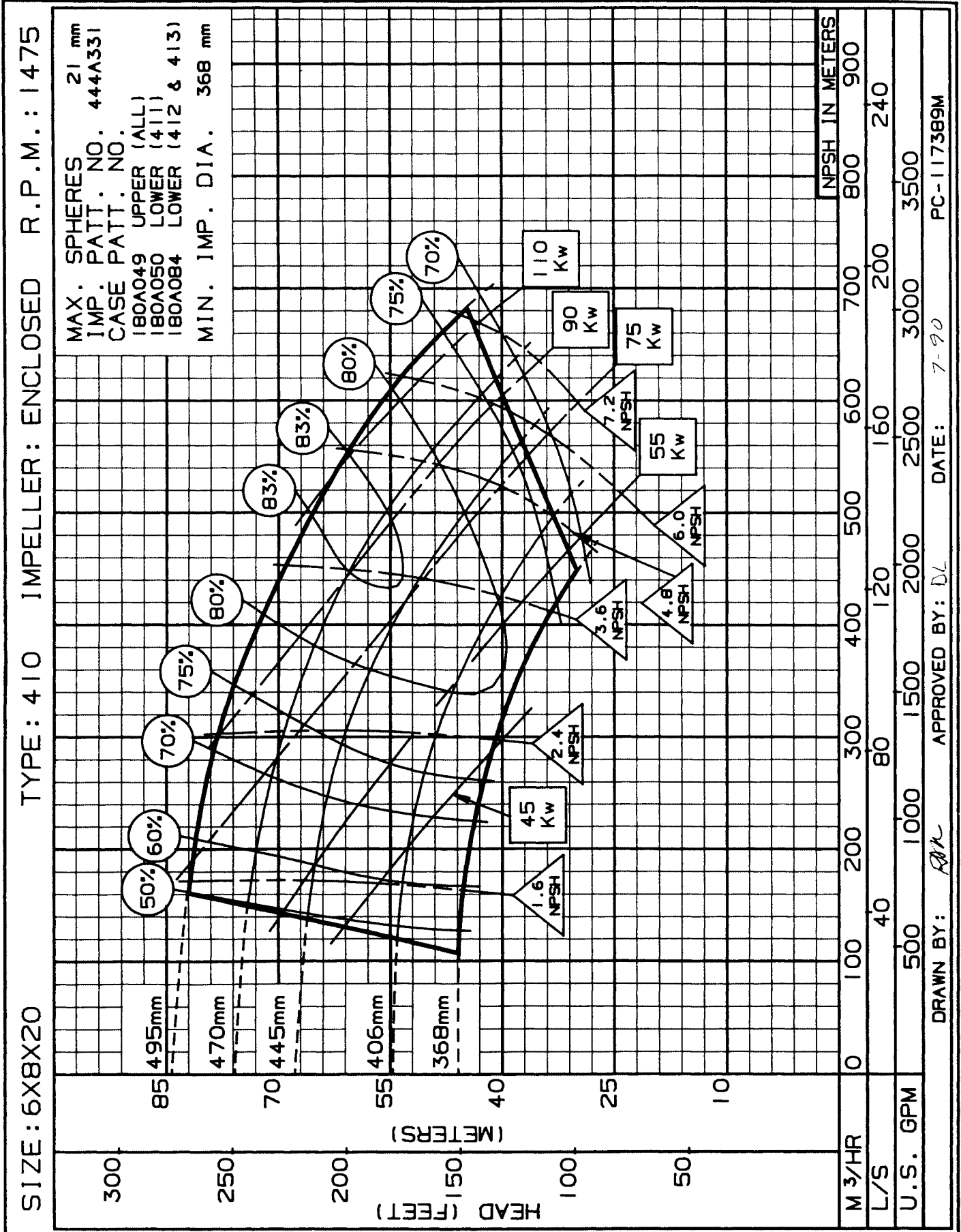

DRAWN BY: *RAK* APPROVED BY: *DL* DATE: 7-90 PC-117389M

SECTION 410 (Metric 50Hz)

DATE JULY 1994

SUPERCEDES MARCH 1986

8x8x11B - 1440 RPM

ENCLOSED IMPELLER



Pentair Pump Group

SIZE: 8X8X11B TYPE: 410 IMPELLER: ENCLOSED R.P.M.: 1440

MAX. SPHERES 32 mm  
 IMP. PATT. NO. 444A332  
 CASE PATT. NO.  
 180A045 UPPER (ALL)  
 180A052 LOWER (411)  
 180A085 LOWER (412 & 413)  
 MIN. IMP. DIA. 184 mm

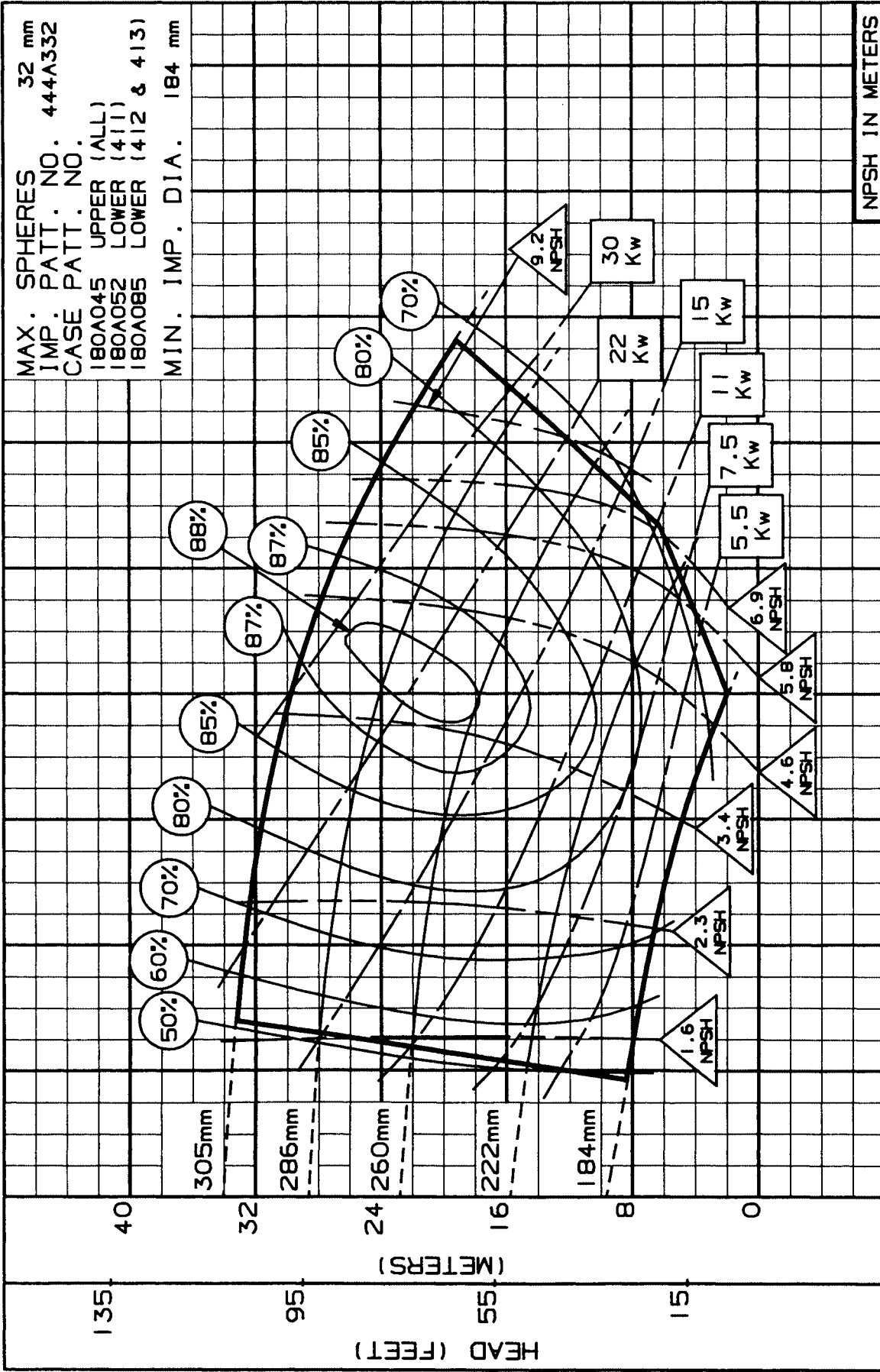

M <sup>3</sup> /HR	0	80	160	240	320	400	480	560	640	720
L/S	0	25	50	75	100	125	150	175	200	2800
U.S. GPM	0	400	800	1200	1600	2000	2400	2800	3200	3600
NPSH IN METERS										

DRAWN BY: *BAZ* APPROVED BY: *DL* DATE: 7-90 PC-131637M

SIZE: 8X8X11B TYPE: 410 IMPELLER: ENCLOSED R.P.M.: 960

MAX. SPHERES 32 mm  
IMP. PATT. NO. 444A332  
CASE PATT. NO.  
180A045 UPPER (ALL)  
180A052 LOWER (411)  
180A085 LOWER (412 & 413)  
MIN. IMP. DIA. 184 mm

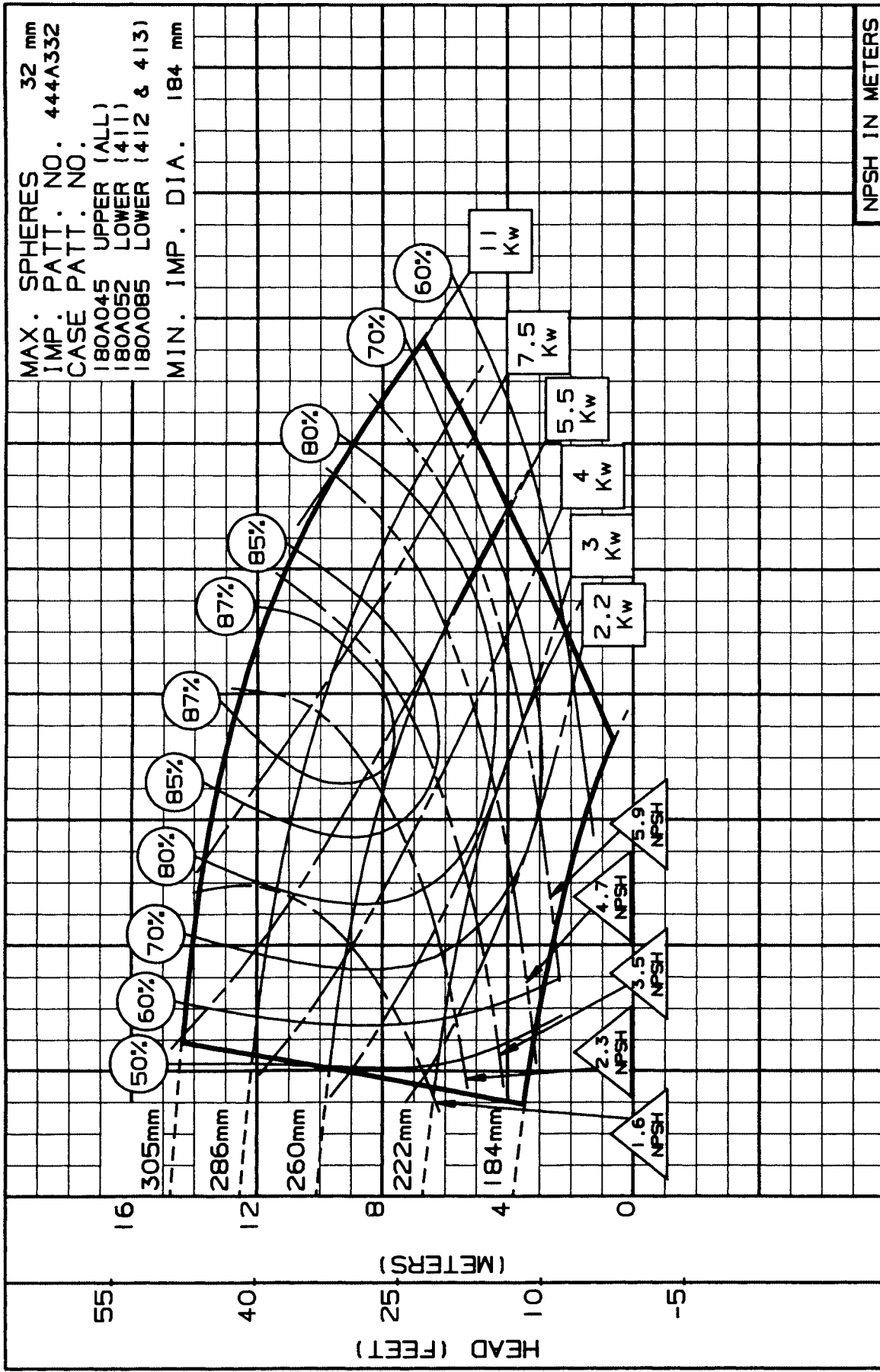

M <sup>3</sup> /HR	0	60	120	180	240	300	360	420	480	540
L/S	0	20	40	60	80	100	120	140	160	180
U.S. GPM	0	400	800	1200	1600	2000	2400	2800	3200	3600
NPSH IN METERS										
DRAWN BY: <i>RAH</i> APPROVED BY: <i>DL</i> DATE: 7-90 PC-131638M										

8x10x12 - 1440 RPM  
 ENCLOSED IMPELLER



SIZE: 8X10X12 TYPE: 410 IMPELLER: ENCLOSED R.P.M.: 1440

MAX. SPHERES 24 mm  
 IMP. PATT. NO. 444A330  
 CASE PATT. NO.  
 180A055 UPPER (ALL)  
 180A056 LOWER (411)  
 180A087 LOWER (412 & 413)  
 MIN. IMP. DIA. 210 mm

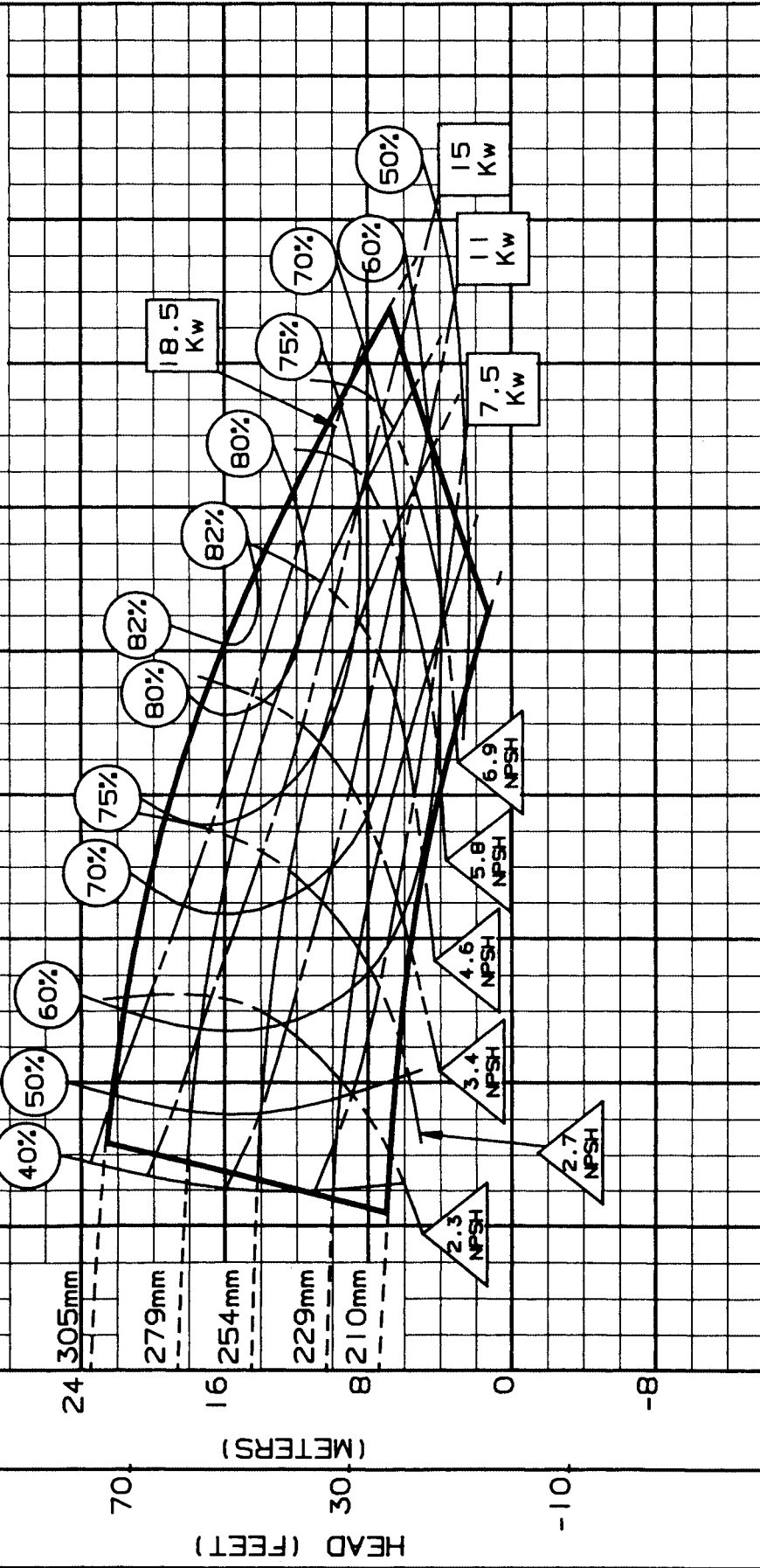

	0	80	160	240	320	400	480	560	640	720
M <sup>3</sup> /HR	0	80	160	240	320	400	480	560	640	720
L/S	25	50	75	100	125	150	175	200	2400	2800
U.S. GPM	400	800	1200	1600	2000	2400	2800	2800	2800	2800
NPSH IN METERS										
DRAWN BY: <i>RAA</i> APPROVED BY: <i>DL</i> DATE: 7-93 PC-117393M										



TYPE: 410 IMPELLER: ENCLOSED R.P.M.: 960

MAX. SPHERES 24 mm  
IMP. PATT. NO. 444A330  
CASE PATT. NO.  
180A055 UPPER (ALL)  
180A056 LOWER (411)  
180A087 LOWER (412 & 413)  
MIN. IMP. DIA. 210 mm

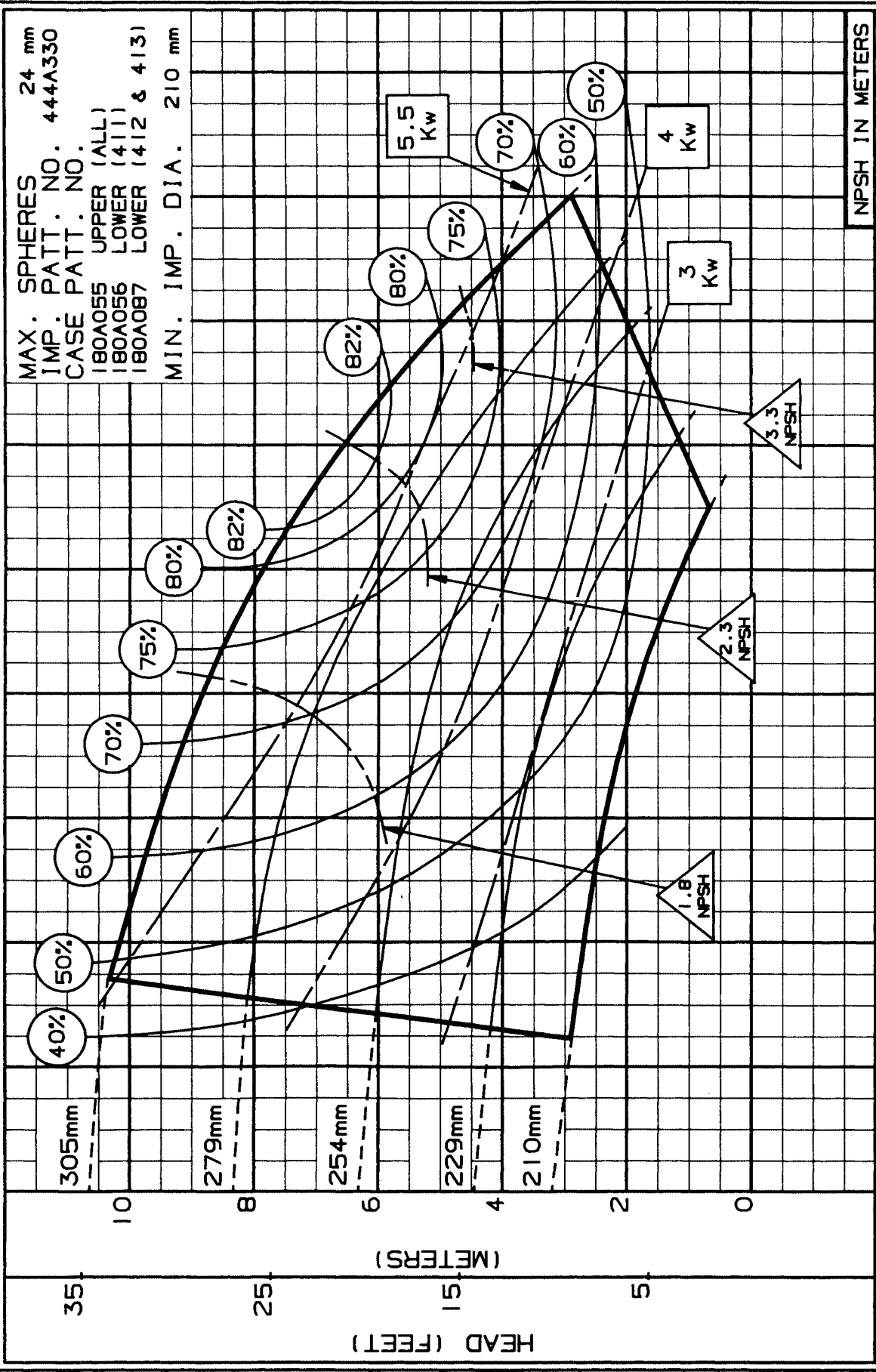

M <sup>3</sup> /HR	0	50	100	150	200	250	300	350	400	450
L/S	15	50	100	150	200	250	300	350	400	450
U.S. GPM	250	500	750	1000	1250	1500	1750			
NPSH IN METERS										
DRAWN BY: <i>BAZ</i> APPROVED BY: DL DATE: 7-90 PC-117394M										

SIZE: 8X10X12A TYPE: 410 IMPELLER: ENCLOSED R.P.M.: 1475

MAX. SPHERES 33 mm  
 IMP. PATT. NO. 444A137  
 CASE PATT. NO.  
 180A055 UPPER (ALL)  
 180A056 LOWER (411)  
 180A087 LOWER (412 & 413)  
 MIN. IMP. DIA. 286 mm

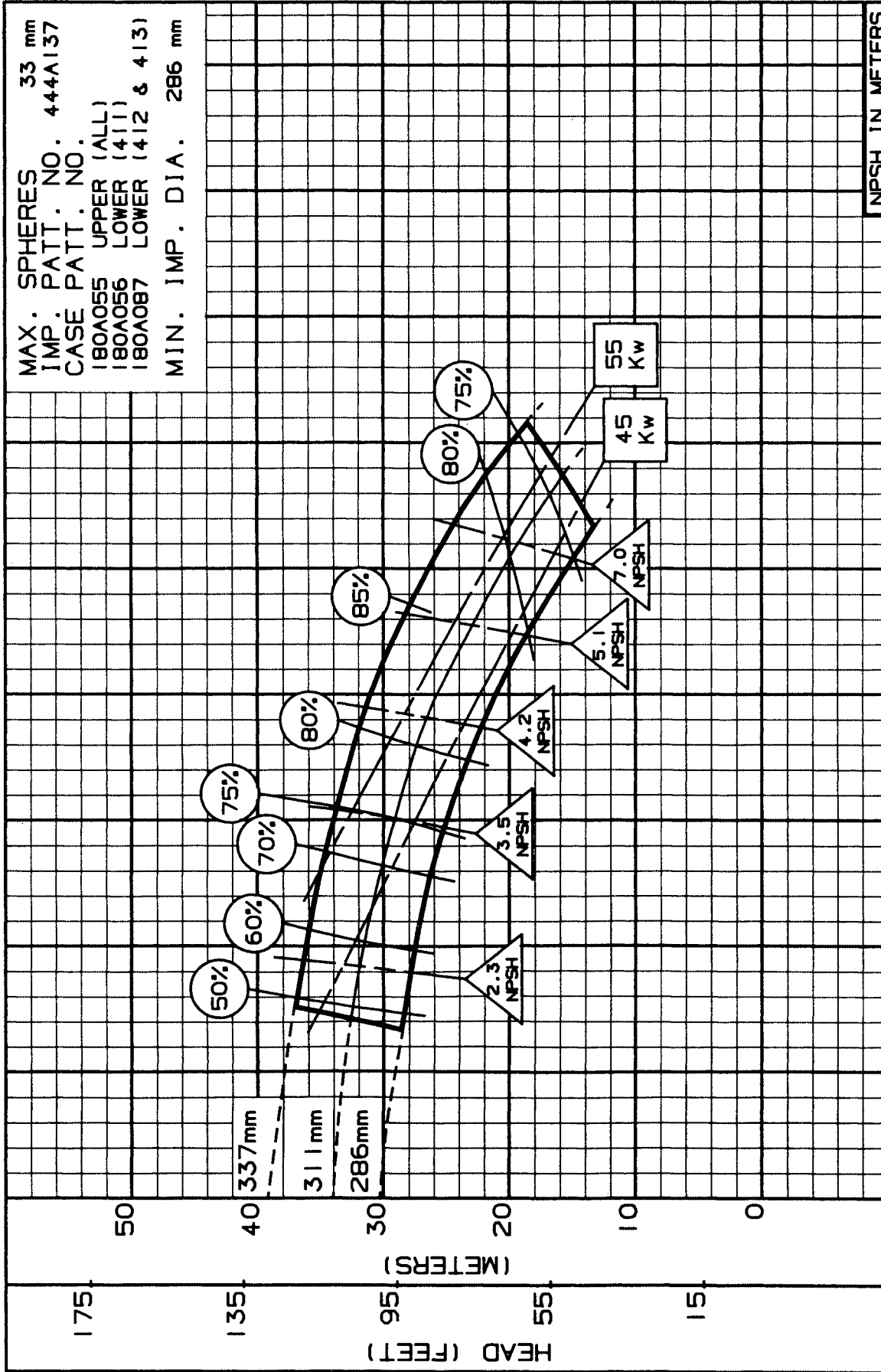

M <sup>3</sup> /HR	0	150	300	450	600	750	900	1050	1200	1350
L/S	0	50	100	150	200	250	300	350	400	450
U.S. GPM	0	750	1500	2250	3000	3750	4500	5250	6000	6750

NPSH IN METERS

DRAWN BY: *Rak* APPROVED BY: *DL* DATE: 7-90 PC-14600M

SIZE: 8X10X12A TYPE: 410 IMPELLER: ENCLOSED R.P.M.: 980

MAX. SPHERES 33 mm  
IMP. PATT. NO. 444A137  
CASE PATT. NO.  
180A055 UPPER (ALL)  
180A056 LOWER (411)  
180A087 LOWER (412 & 413)  
MIN. IMP. DIA. 286 mm

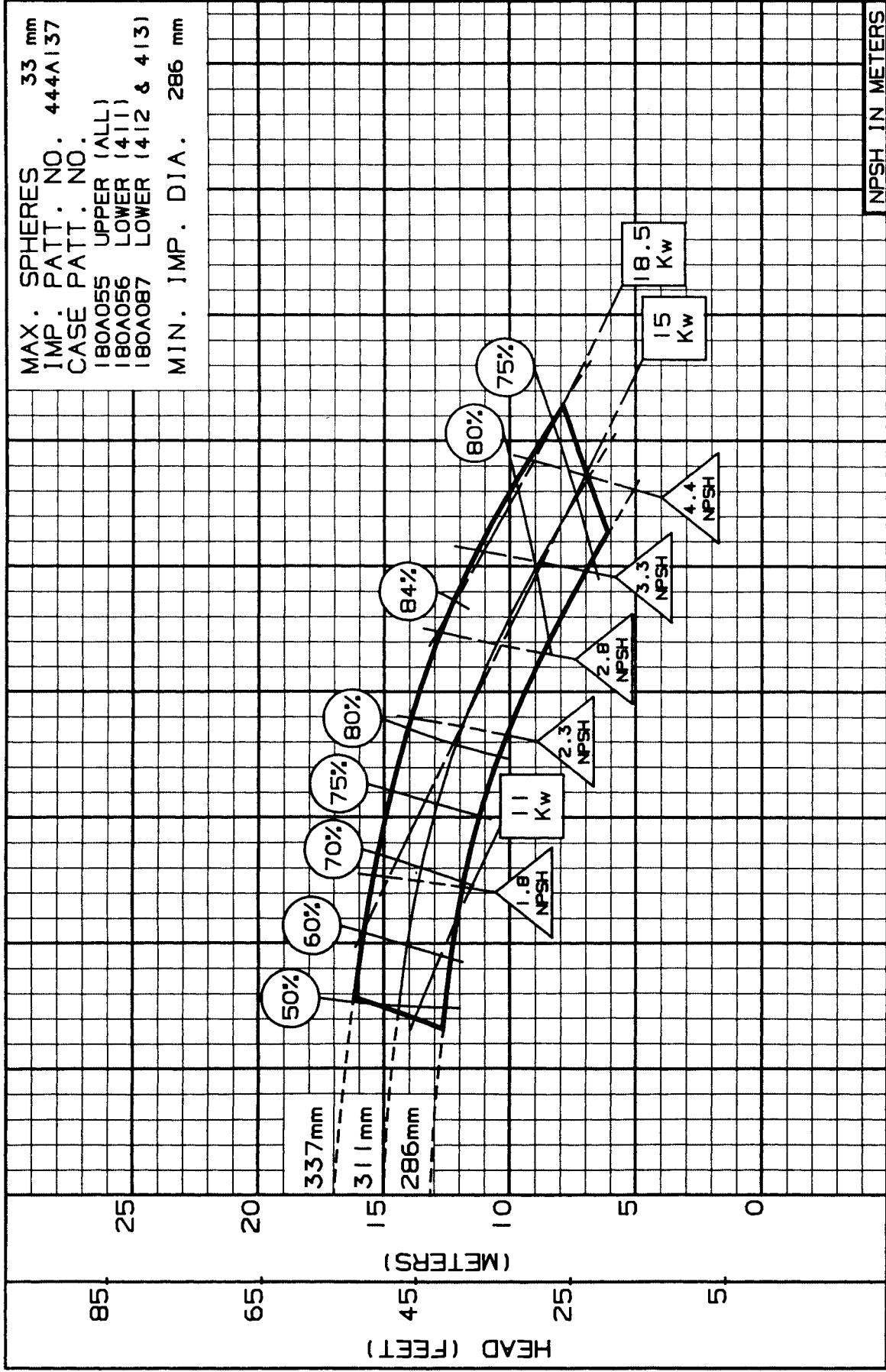

M <sup>3</sup> /HR	0	100	200	300	400	500	600	700	800	900
L/S	40	120	240	360	480	600	720	840	960	1080
U.S. GPM	500	1000	1500	2000	2500	3000	3500	4000	4500	5000
NPSH IN METERS										

DRAWN BY: *AP* APPROVED BY: DL DATE: 7-92 PC-145999M

8x10x15A - 1475 RPM  
 ENCLOSED IMPELLER

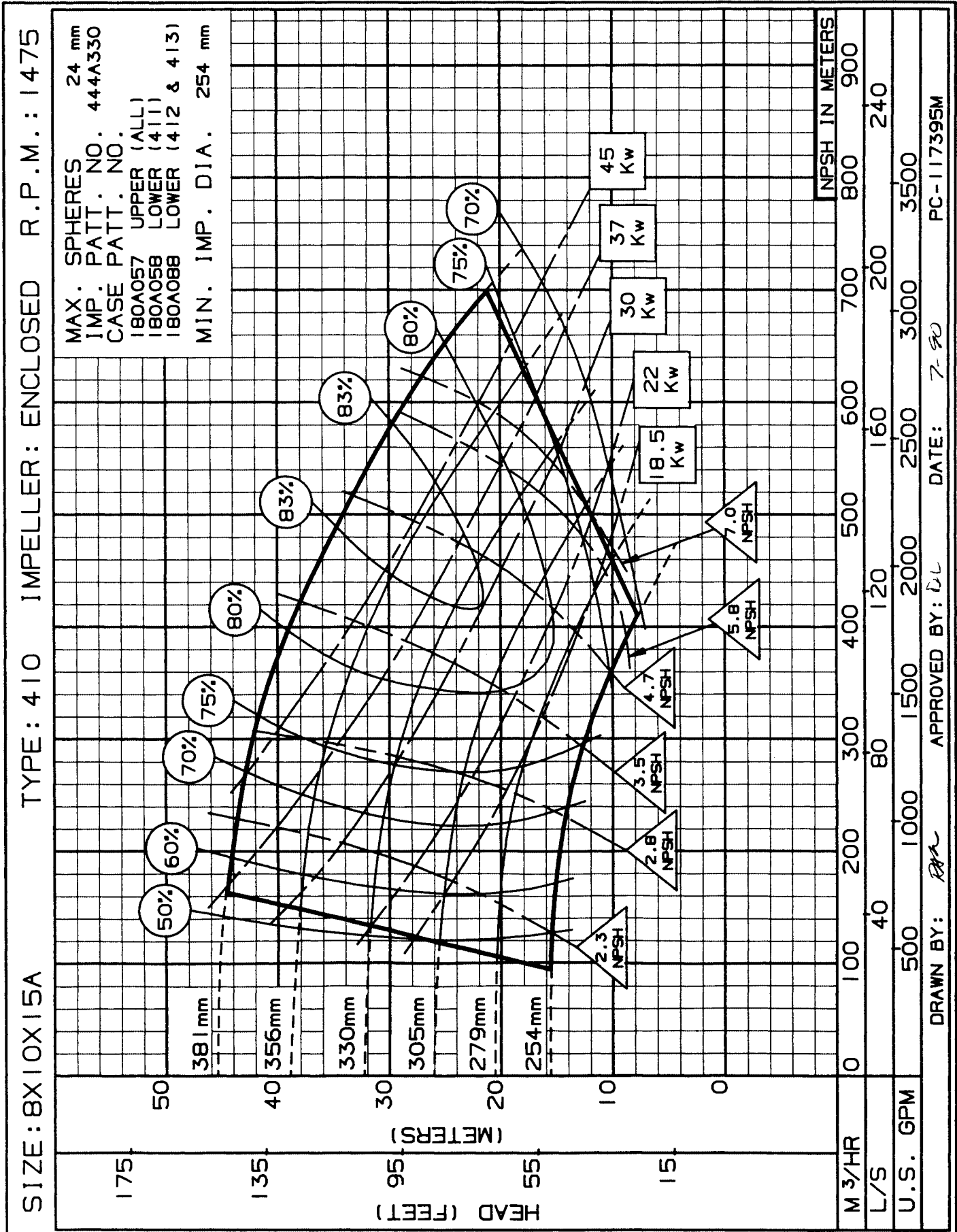

SIZE: 8X10X15A TYPE: 410 IMPELLER: ENCLOSED R.P.M.: 960

MAX. SPHERES 24 mm  
IMP. PATT. NO. 444A330  
CASE PATT. NO.  
180A057 UPPER (ALL)  
180A058 LOWER (411)  
180A088 LOWER (412 & 413)  
MIN. IMP. DIA. 254 mm

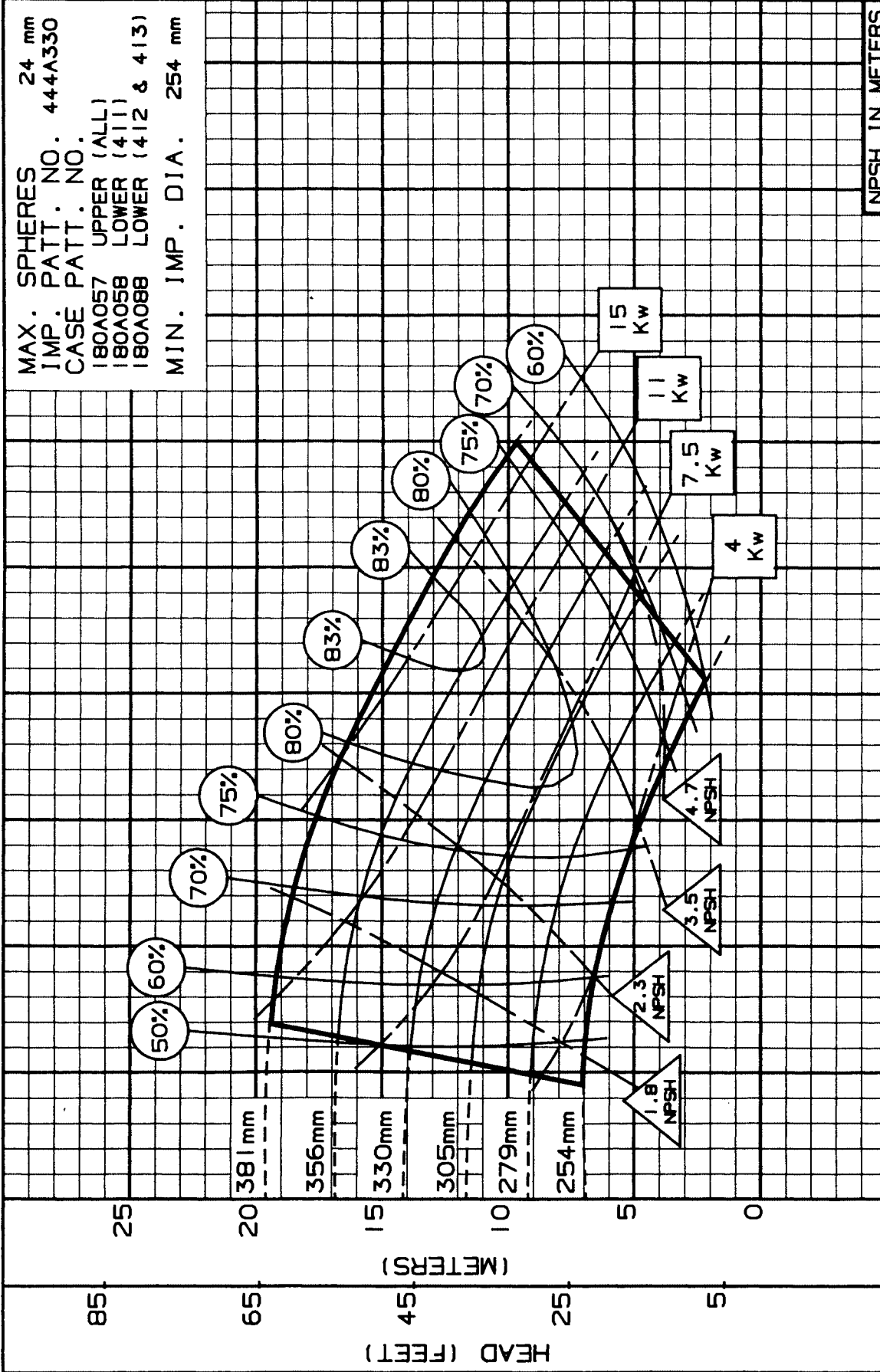

M <sup>3</sup> /HR	0	75	150	225	300	375	450	525	600	675
L/S	25	50	75	100	125	150	175			
U.S. GPM	400	800	1200	1600	2000	2400	2800			
NPSH IN METERS										

DRAWN BY: *APC* APPROVED BY: DC DATE: 7-90 PC-117396M

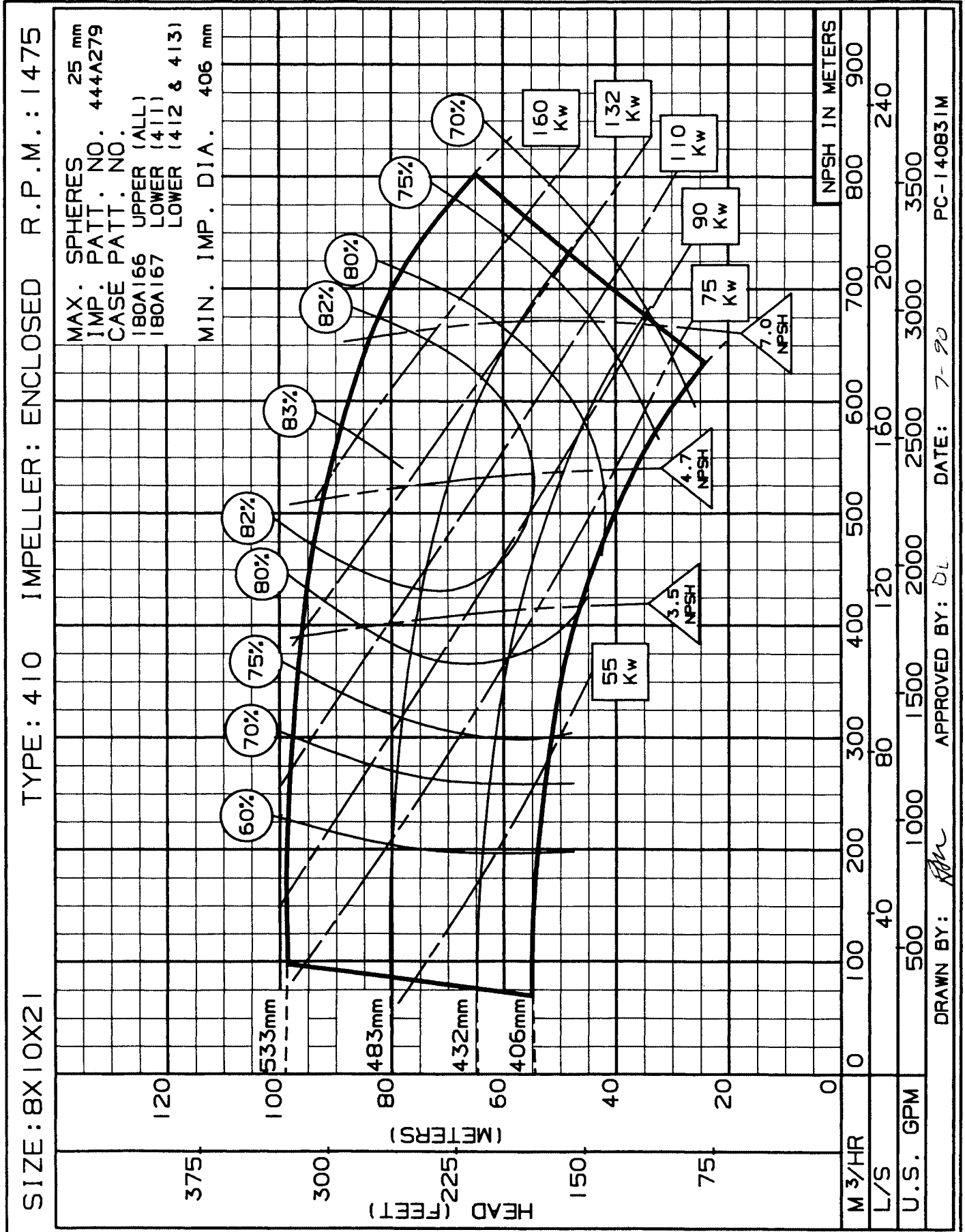

SIZE: 8X10X21 TYPE: 410 IMPELLER: ENCLOSED R.P.M.: 980

MAX. SPHERES 25 mm  
IMP. PATT. NO. 444A279  
CASE PATT. NO.  
180A166 UPPER (ALL)  
180A167 LOWER (411 & 413)  
MIN. IMP. DIA. 406 mm

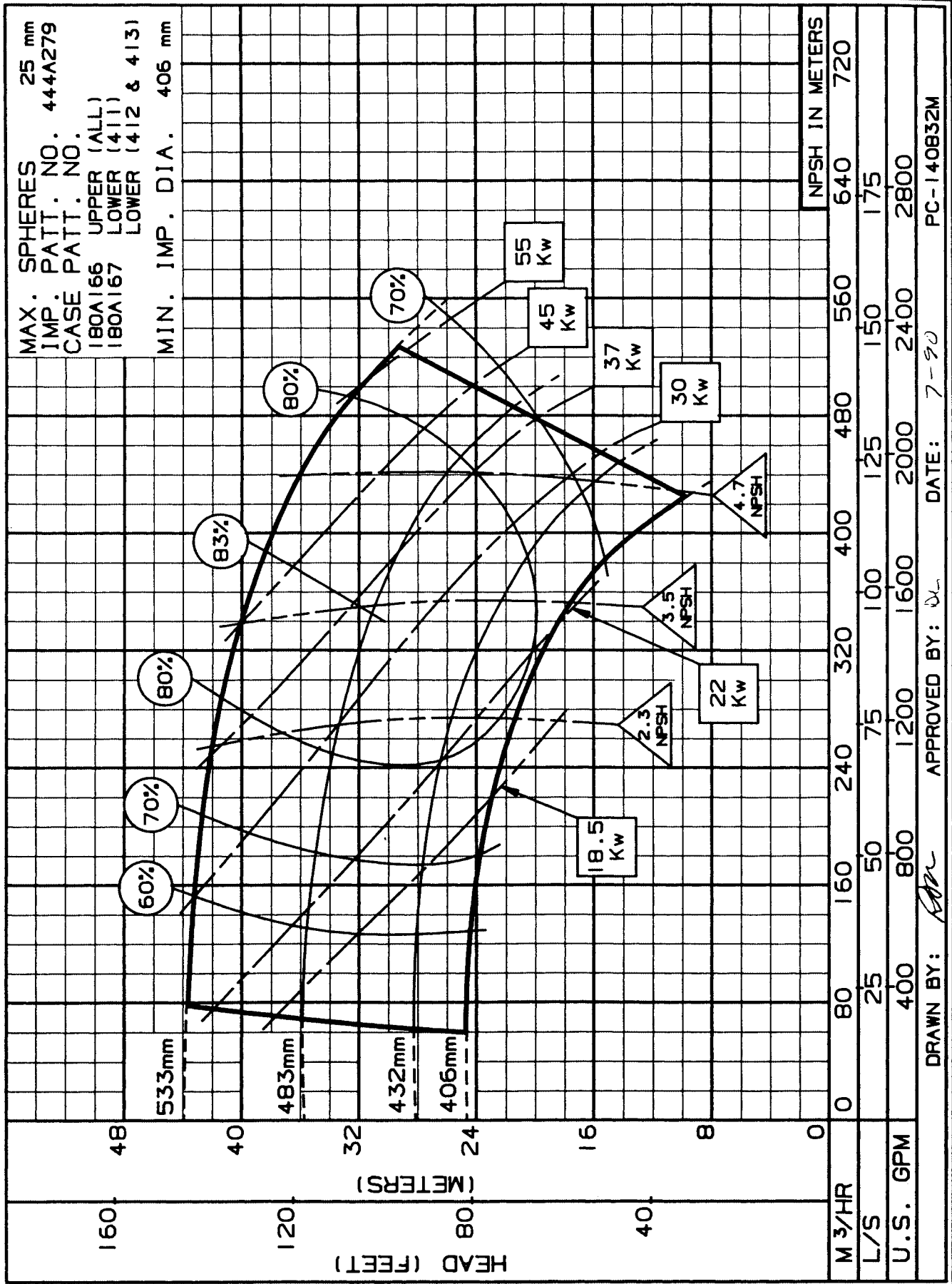

M <sup>3</sup> /HR	0	80	160	240	320	400	480	560	640	720
L/S	0	25	50	75	100	125	150	175		
U.S. GPM	0	400	800	1200	1600	2000	2400	2800		
NPSH IN METERS										

DRAWN BY: *[Signature]* APPROVED BY: *[Signature]* DATE: 7-90 PC-140B32M

# 8x10x21A - 1475 RPM

## ENCLOSED IMPELLER



Pentair Pump Group

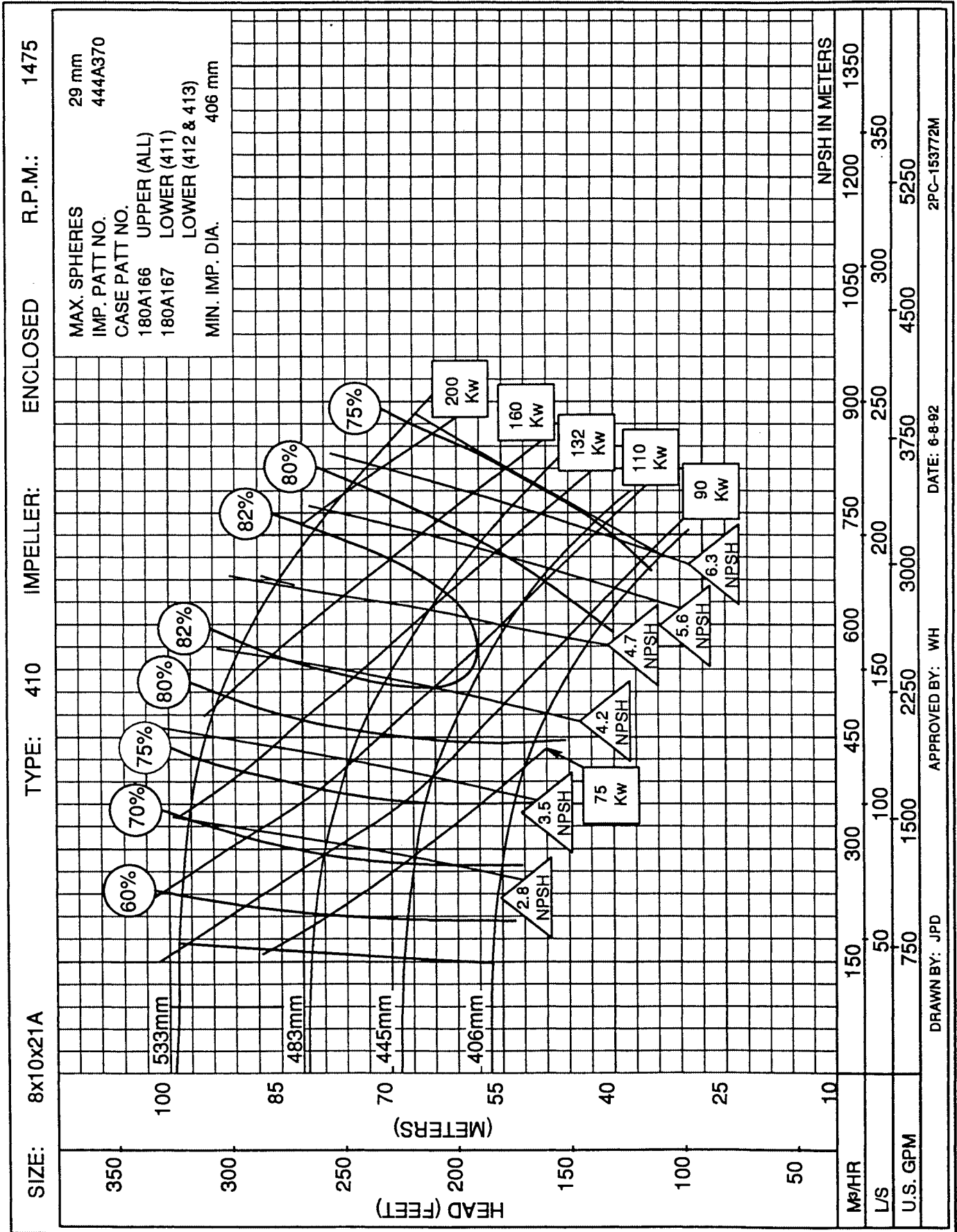



SIZE: **8x10x21A** TYPE: **410** IMPELLER: **ENCLOSED** R.P.M.: **980**

MAX. SPHERES  
IMP. PATT NO. 29 mm  
444A370  
CASE PATT NO.  
180A166 UPPER (ALL)  
180A167 LOWER (411)  
LOWER (412 & 413)  
MIN. IMP. DIA. 406 mm

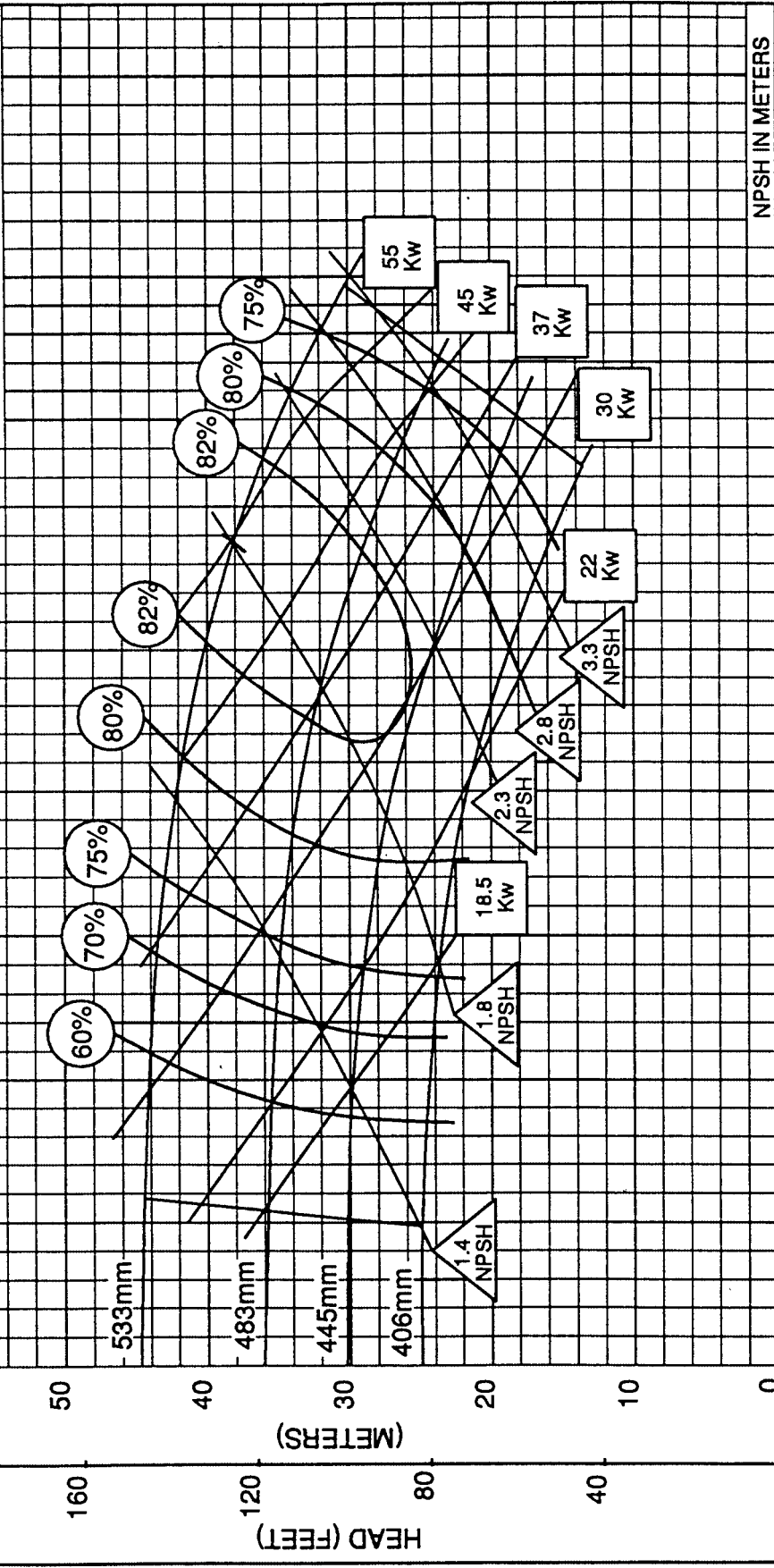

M <sup>3</sup> /HR	75	150	225	300	375	450	525	600	675
L/S	25	50	75	100	125	150	175	200	2400
U.S. GPM	400	800	1200	1600	2000	2400	2800	2800	2800

DATE: 6-8-92  
APPROVED BY: WH  
DRAWN BY: JPD  
2PC-15373M

**SIZE : 8x12x24**

**TYPE : 410**

**IMPELLER : Enclosed**

**R. P. M. : 1475**

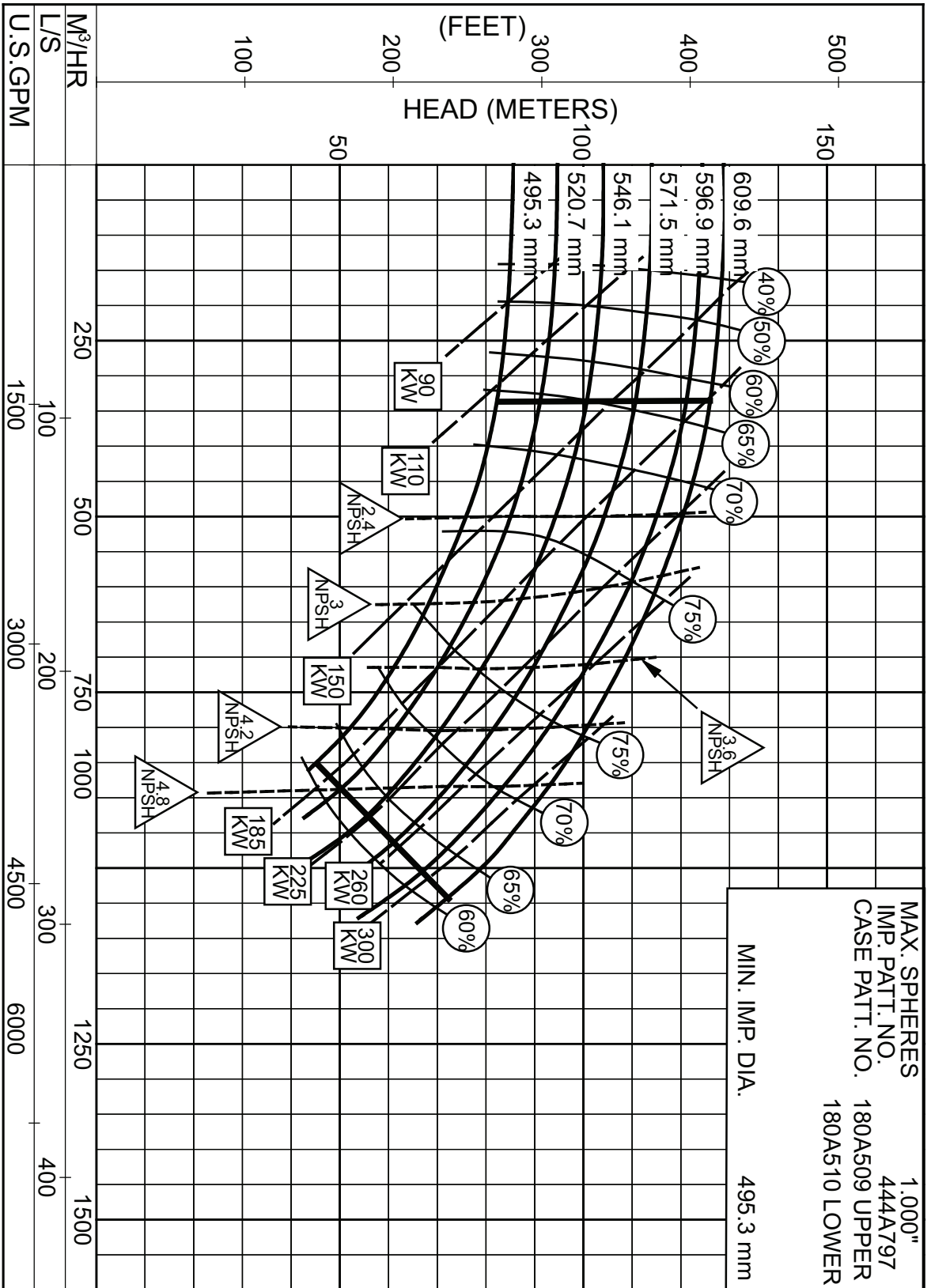

**PC-197422**

# 10x12x12B - 1440 RPM

## ENCLOSED IMPELLER



Pentair Pump Group

SIZE: 10X12X12B TYPE: 410 IMPELLER: ENCLOSED R.P.M.: 1440

MAX. SPHERES 24 mm  
 IMP. PATT. NO. 444A144  
 CASE PATT. NO.  
 180A219 UPPER (ALL)  
 180A220 LOWER (411)  
 LOWER (412 & 413)  
 MIN. IMP. DIA. 251 mm

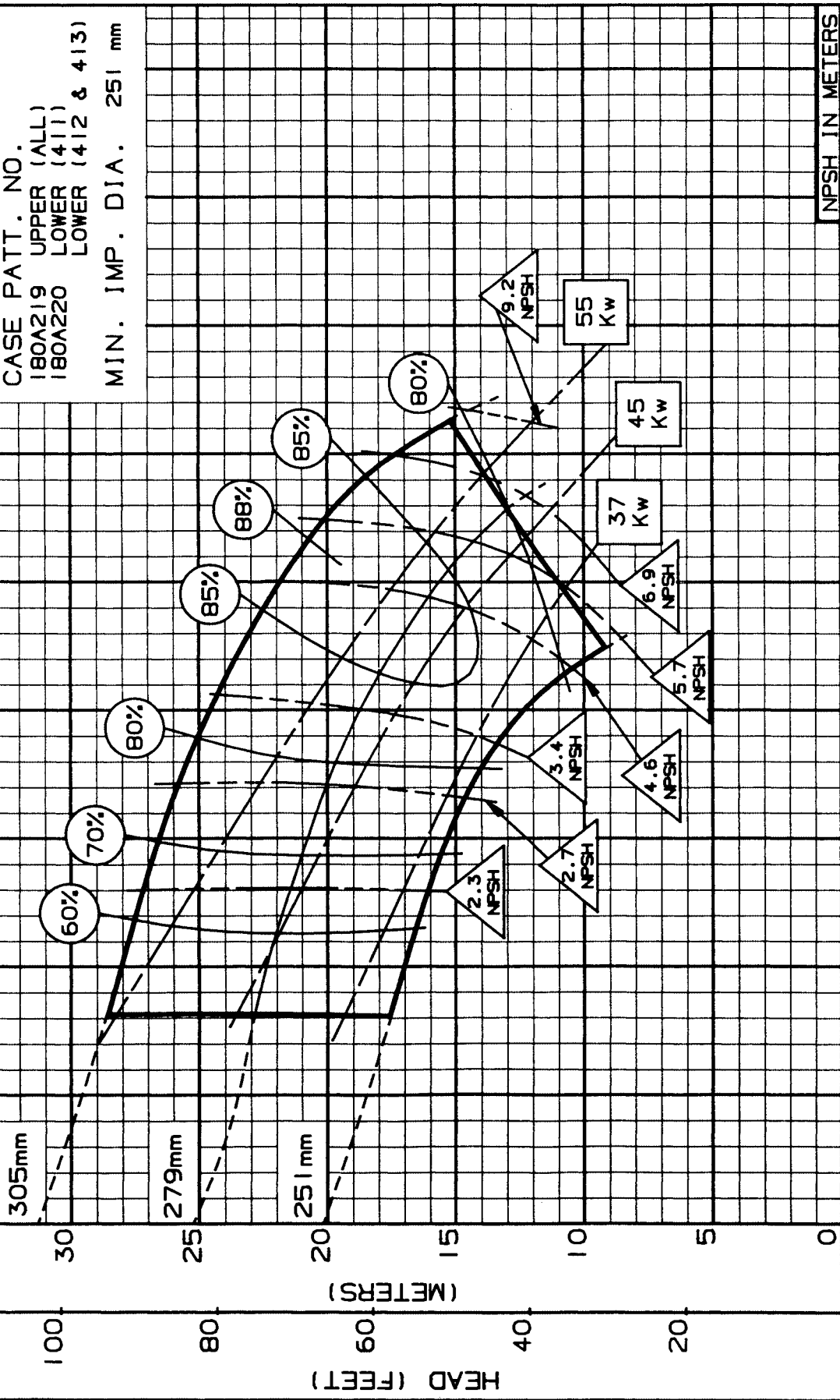

M 3/HR	0	200	400	600	800	1000	1200	1400	1600	1800
L/S	0	60	120	180	240	300	360	420	480	
U.S. GPM	0	1000	2000	3000	4000	5000	6000	7000		

DRAWN BY: *[Signature]* APPROVED BY: *[Signature]* DATE: 7-90 PC-117399M

SIZE: 10X12X12B TYPE: 410 IMPELLER: ENCLOSED R.P.M.: 980

MAX. SPHERES 24 mm  
IMP. PATT. NO. 444A144  
CASE PATT. NO.  
180A219 UPPER (ALL)  
180A220 LOWER (411)  
LOWER (412 & 413)  
MIN. IMP. DIA. 251 mm

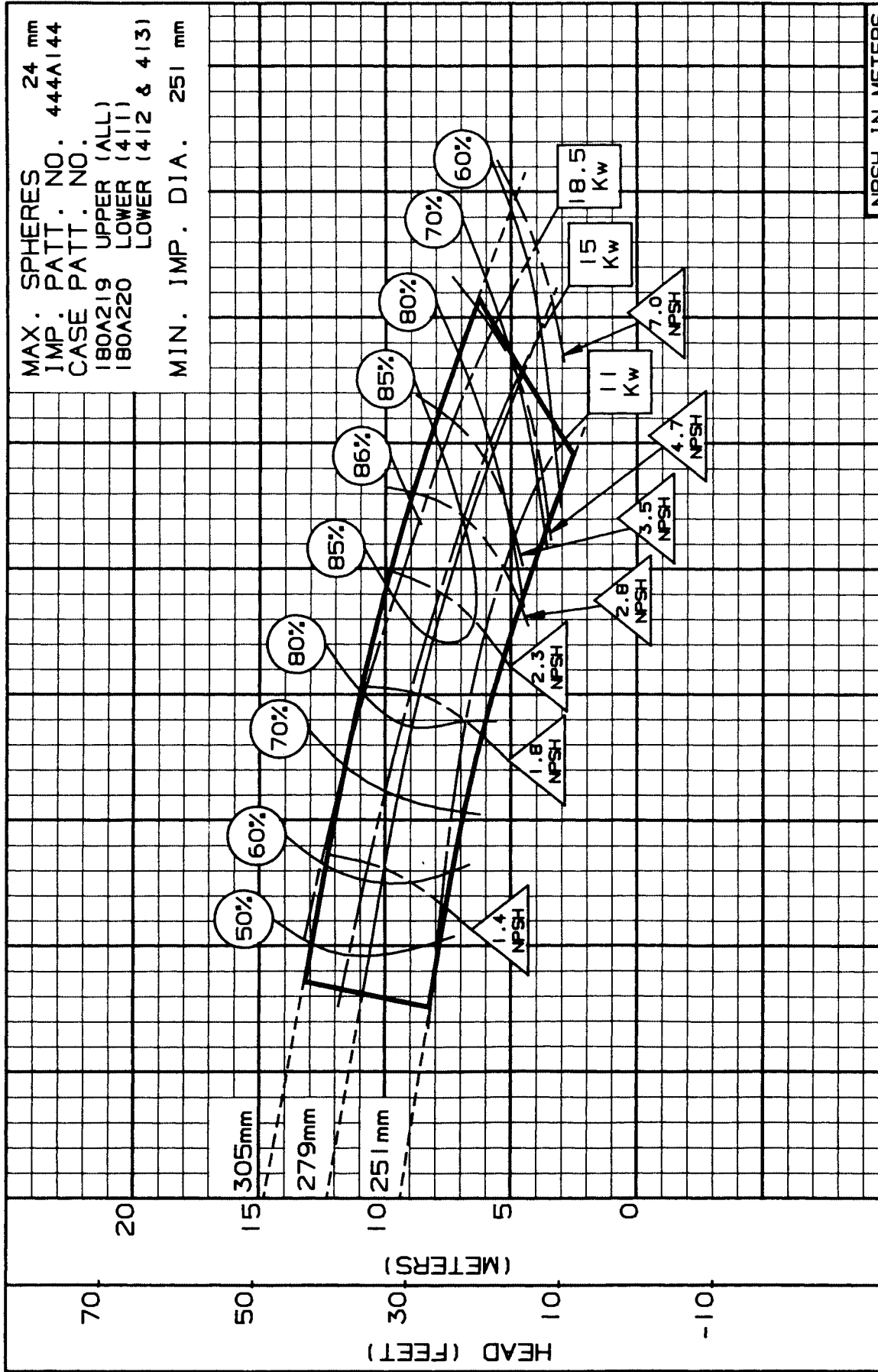

M <sup>3</sup> /HR	0	125	250	375	500	625	750	875	1000	1125
L/S	40	600	1200	1800	2400	3000	3600	4200		
U.S. GPM										
NPSH IN METERS										

DRAWN BY: *RAH* APPROVED BY: *DL* DATE: 7-90 PC-117400M

SIZE: 10X12X15B TYPE: 410 IMPELLER: ENCLOSED R.P.M.: 1475

MAX. SPHERES 36 mm  
 IMP. PATT. NO. 444A145  
 CASE PATT. NO.  
 180A221 UPPER (ALL)  
 180A222 LOWER (411)  
 LOWER (412 & 413)  
 MIN. IMP. DIA. 305 mm

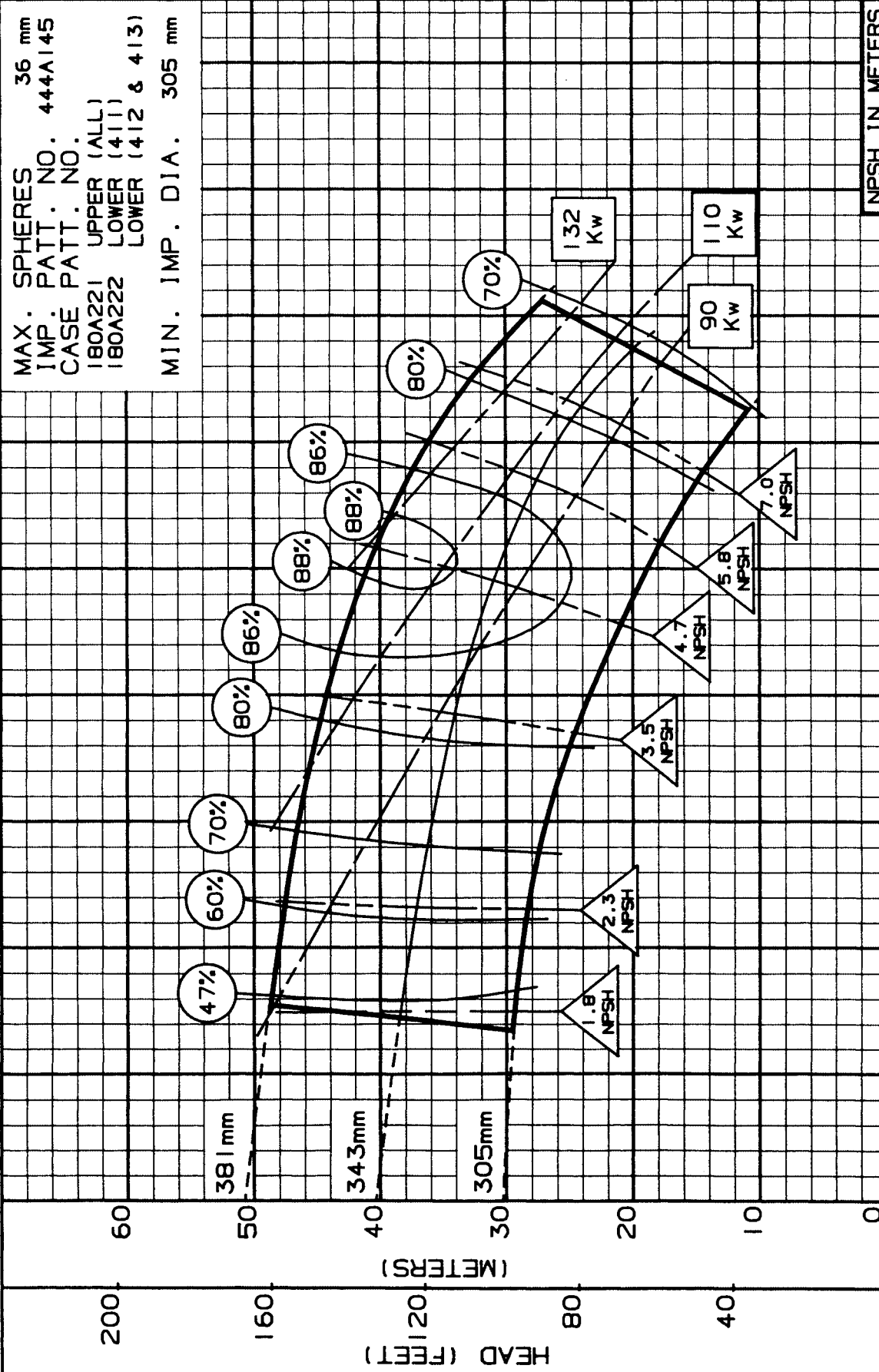

M <sup>3</sup> /HR	0	200	400	600	800	1000	1200	1400	1600	1800
L/S	0	60	120	180	240	300	360	420	480	
U.S. GPM	0	1000	2000	3000	4000	5000	6000	7000		
DRAWN BY: <i>[Signature]</i> APPROVED BY: DL DATE: 7-90 PC-117401M										

SIZE: 10X12X15B TYPE: 410 IMPELLER: ENCLOSED R.P.M.: 980

MAX. SPHERES 36 mm  
IMP. PATT. NO. 444A145  
CASE PATT. NO.  
180A221 UPPER (ALL)  
180A222 LOWER (411)  
LOWER (412 & 413)  
MIN. IMP. DIA. 305 mm

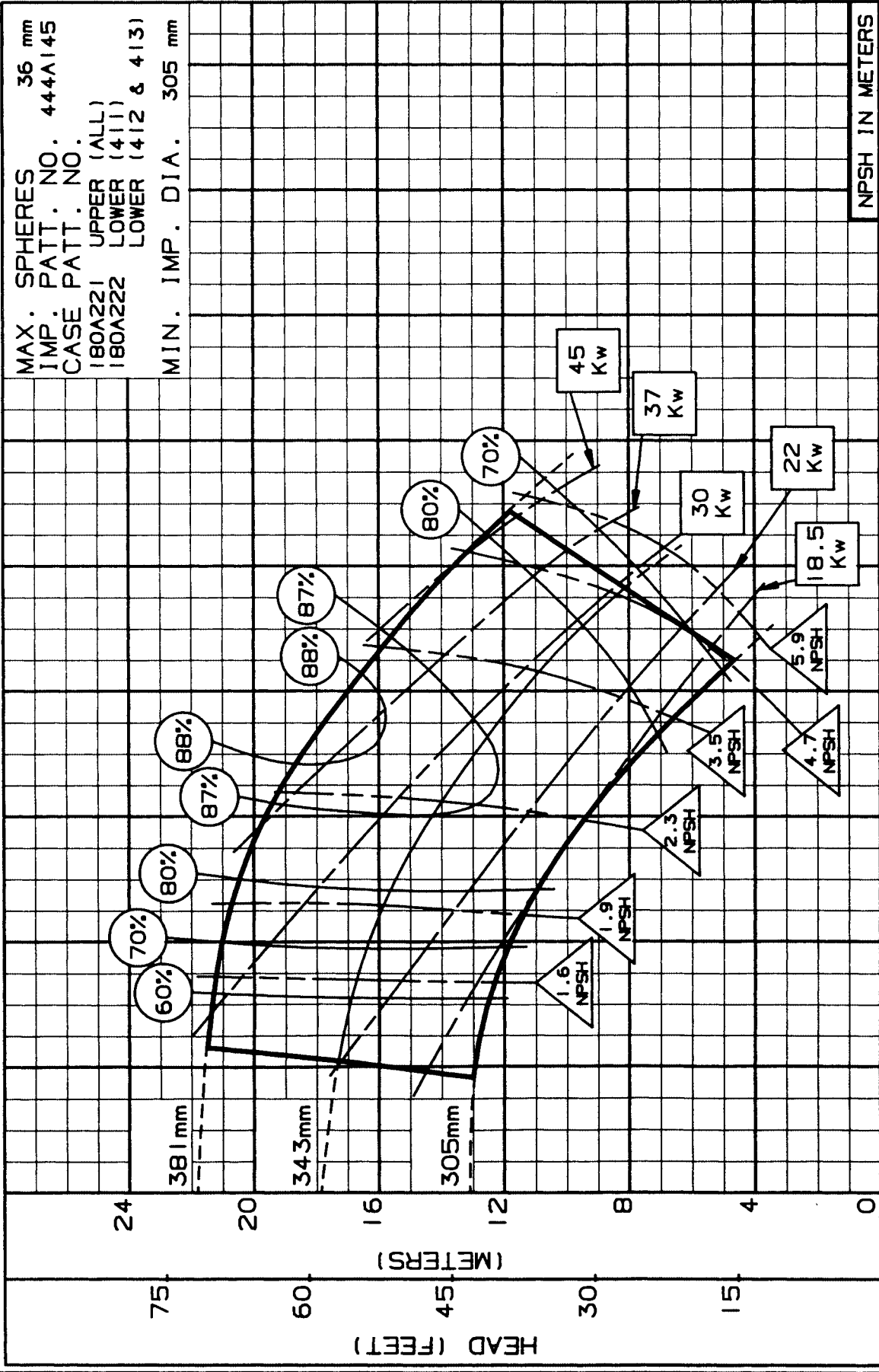

M <sup>3</sup> /HR	0	200	400	600	800	1000	1200	1400	1600	1800
L/S	60	120	180	240	300	360	420	480	540	600
U.S. GPM	1000	2000	3000	4000	5000	6000	7000	8000	9000	10000

DRAWN BY: *[Signature]* APPROVED BY: *[Signature]* DATE: 7-90 PC-117402M

10x12x15C - 1475 RPM

ENCLOSED IMPELLER



Pentair Pump Group

SIZE: 10X12X15C TYPE: 410 IMPELLER: ENCLOSED R.P.M.: 1475

MAX. SPHERES 29 mm  
 IMP. PATT. NO. 4340  
 CASE PATT. NO.  
 180A221 UPPER (ALL)  
 180A222 LOWER (411)  
 LOWER (412 & 413)  
 MIN. IMP. DIA. 318 mm

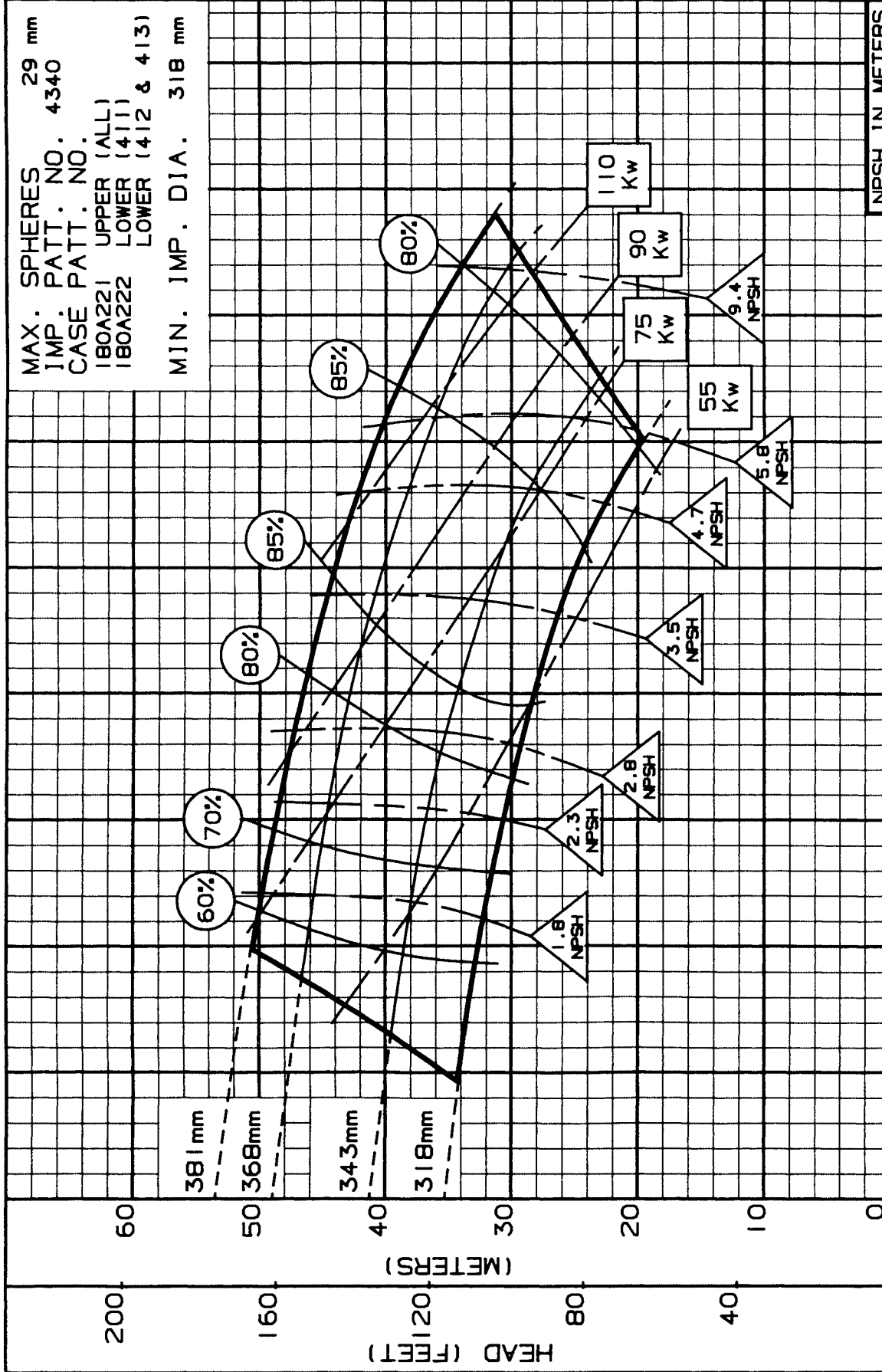

M <sup>3</sup> /HR	0	150	300	450	600	750	900	1050	1200	1350
L/S	0	50	100	150	200	250	300	350	400	450
U.S. GPM	0	750	1500	2250	3000	3750	4500	5250	6000	6750
NPSH IN METERS										

DRAWN BY: *APC* APPROVED BY: *bt* DATE: 7-90 PC-125182M

SIZE: 10X12X15C TYPE: 410 IMPELLER: ENCLOSED R.P.M.: 980

MAX. SPHERES 29 mm  
IMP. PATT. NO. 4340  
CASE PATT. NO.  
180A221 UPPER (ALL)  
180A222 LOWER (411)  
LOWER (412 & 413)  
MIN. IMP. DIA. 318 mm

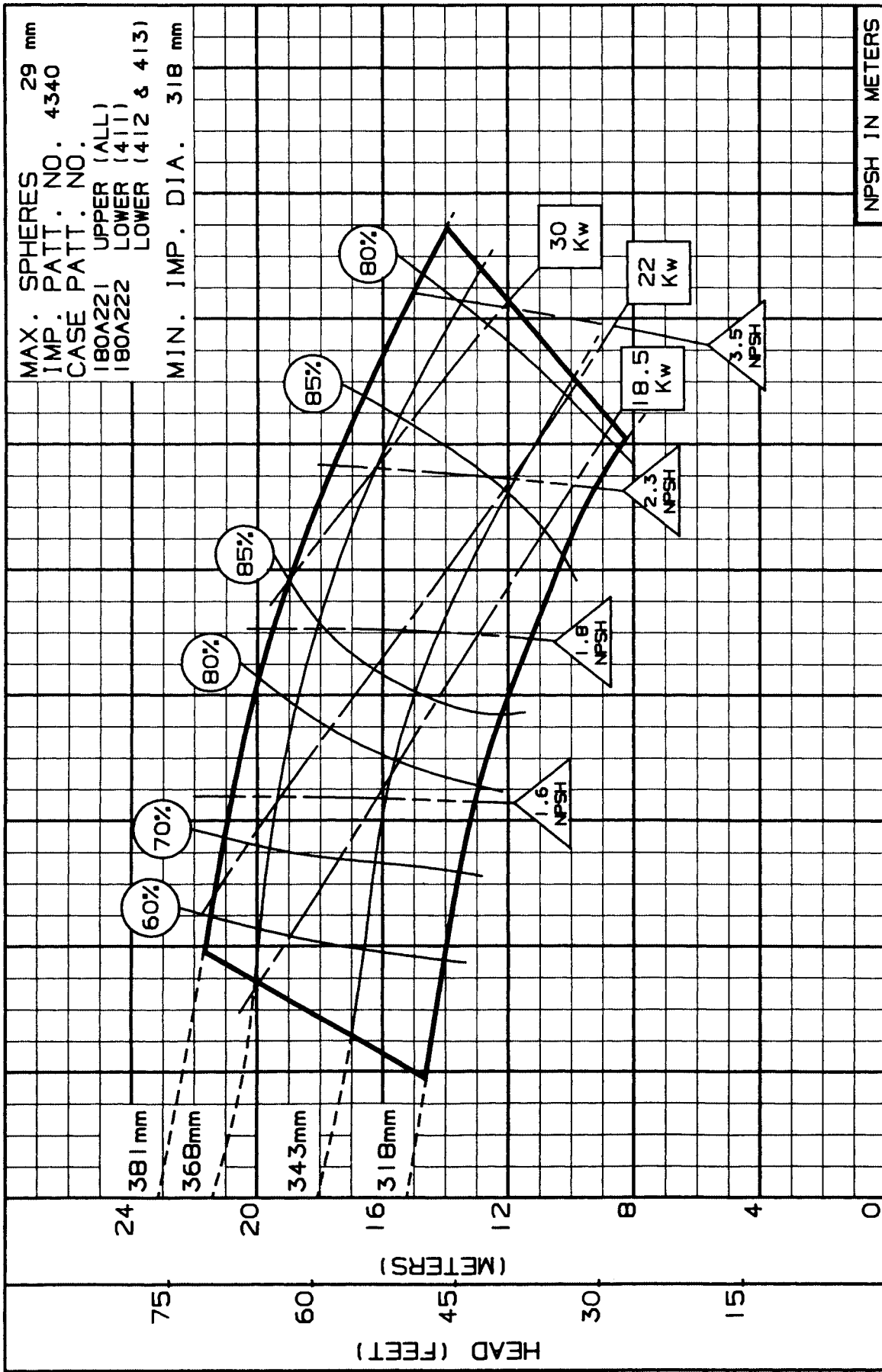

M <sup>3</sup> /HR	0	100	200	300	400	500	600	700	800	900
L/S	40	160	320	480	640	800	960	1120	1280	1440
U.S. GPM	500	1000	1500	2000	2500	3000	3500	4000	4500	5000

DRAWN BY: *DL* APPROVED BY: *DL* DATE: 7-94 PC-1251B1M



10x12x18 - 1475 RPM

ENCLOSED IMPELLER



Pentair Pump Group

SIZE: 10X12X18 TYPE: 410 IMPELLER: ENCLOSED R.P.M.: 1475

MAX. SPHERES 40 mm  
 IMP. PATT. NO. 444A146  
 CASE PATT. NO.  
 180A223 UPPER (ALL)  
 180A224 LOWER (411)  
 LOWER (412 & 413)  
 MIN. IMP. DIA. 381 mm

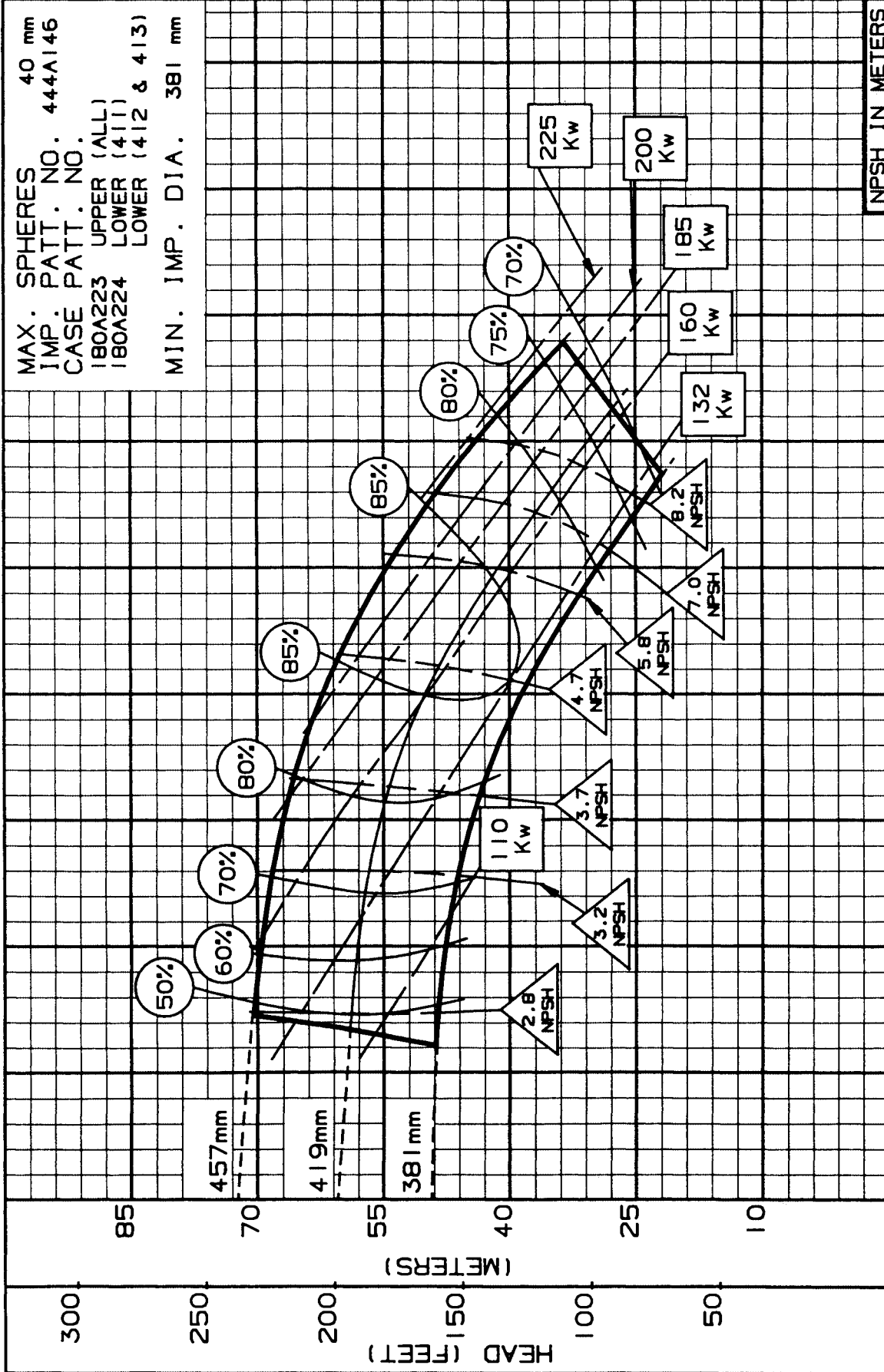

M <sup>3</sup> /HR	0	250	75	150	300	450	600	750	900	1000	1250	1500	1750	2000	2250
L/S															
U.S. GPM	1500	3000	4500	6000	7500	9000	600	900	1200	1500	1800	2100	2400	2700	3000
DRAWN BY: <i>DL</i> APPROVED BY: <i>DL</i> DATE: 7-94 PC-117403M															

SIZE: 10X12X18 TYPE: 410 IMPELLER: ENCLOSED R.P.M.: 980

MAX. SPHERES 40 mm  
IMP. PATT. NO. 444A146  
CASE PATT. NO.  
180A223 UPPER (ALL)  
180A224 LOWER (411)  
LOWER (412 & 413)  
MIN. IMP. DIA. 381 mm

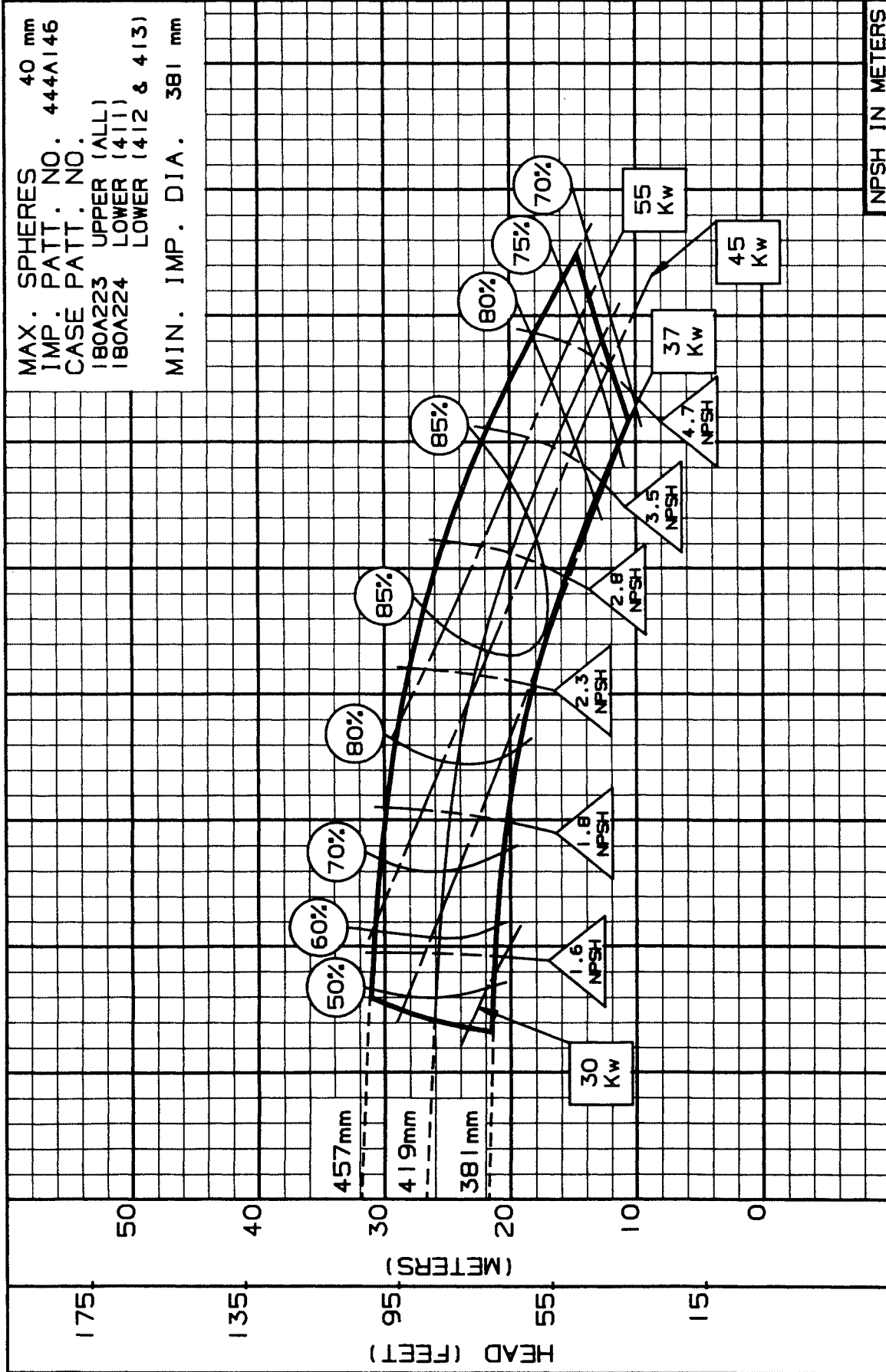

DRAWN BY: *BAK* APPROVED BY: DL DATE: 7-94 PC-117404M

12x14x15B - 1475 RPM  
 ENCLOSED IMPELLER



SIZE: 12X14X15B TYPE: 410 IMPELLER: ENCLOSED R.P.M.: 1475

MAX. SPHERES 27 mm  
 IMP. PATT. NO. 444A147  
 CASE PATT. NO.  
 180A225 UPPER (ALL)  
 180A226 LOWER (411)  
 LOWER (412 & 413)  
 MIN. IMP. DIA. 305 mm

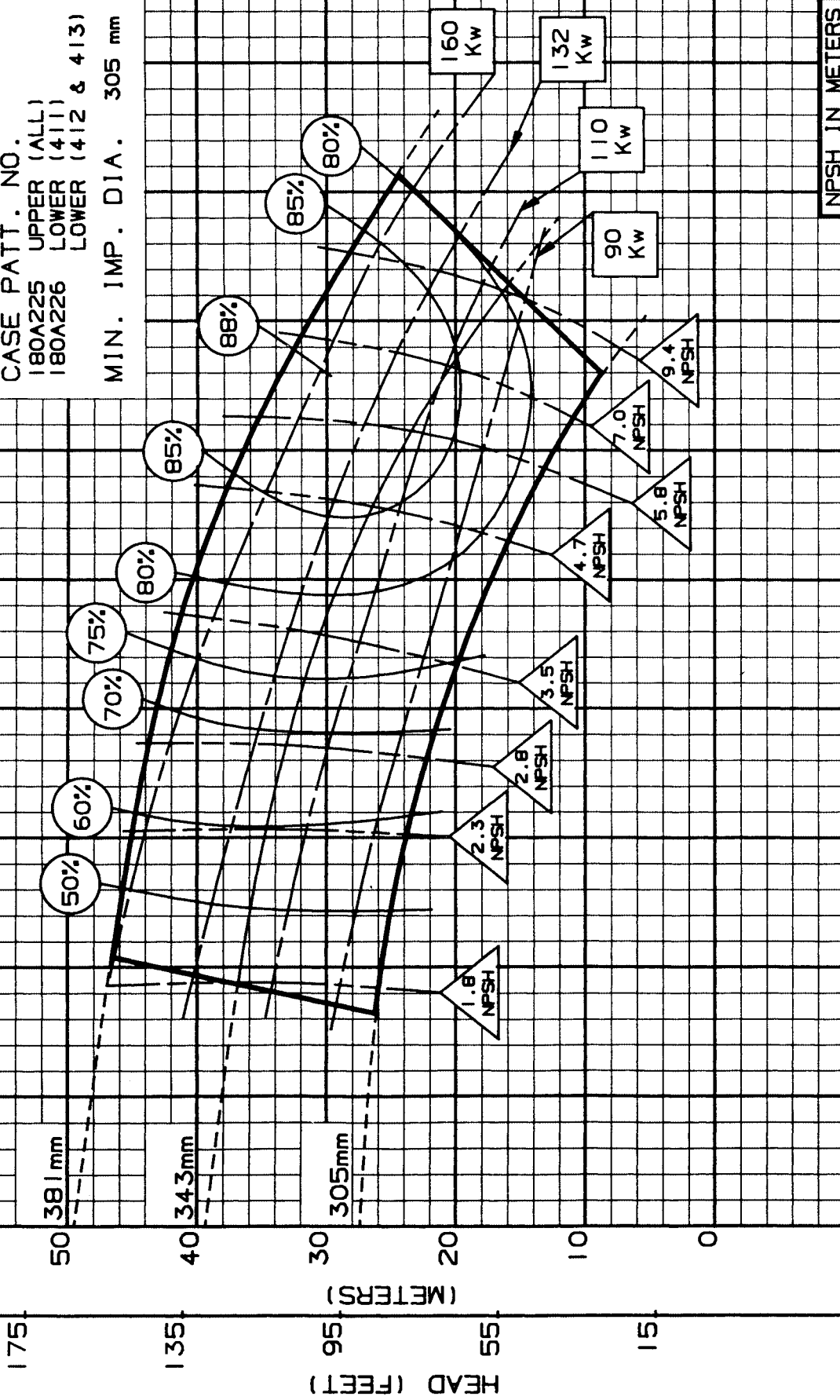

M <sup>3</sup> /HR	0	250	500	750	1000	1250	1500	1750	2000	2250
L/S	75	150	225	300	375	450	525	600	675	750
U.S. GPM	150	300	450	600	750	900	1050	1200	1350	1500

NPSH IN METERS: 0, 10, 20, 30, 40, 50  
 DATE: 7-90  
 APPROVED BY: DL  
 DRAWN BY: *ARC*  
 PC-132822M

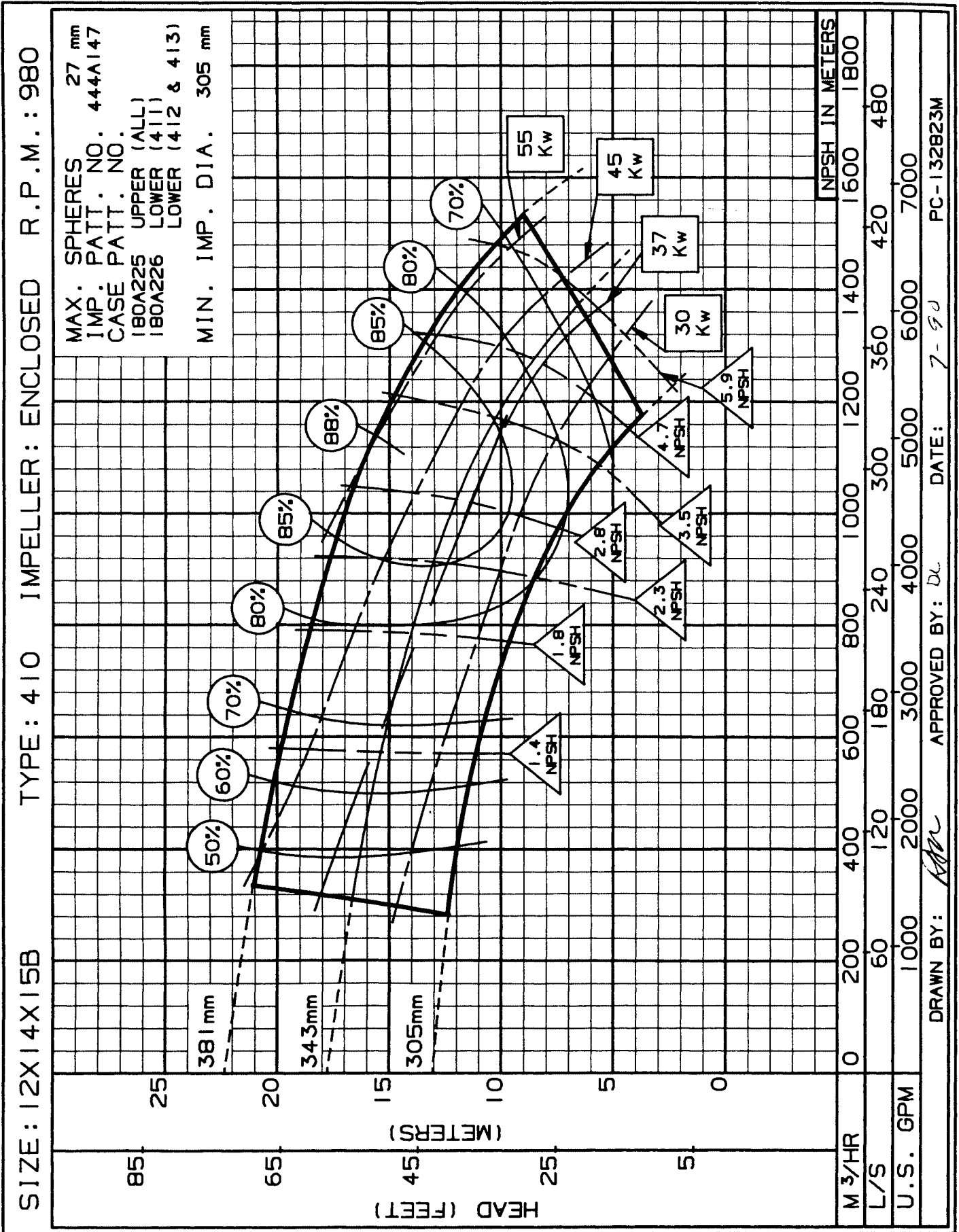

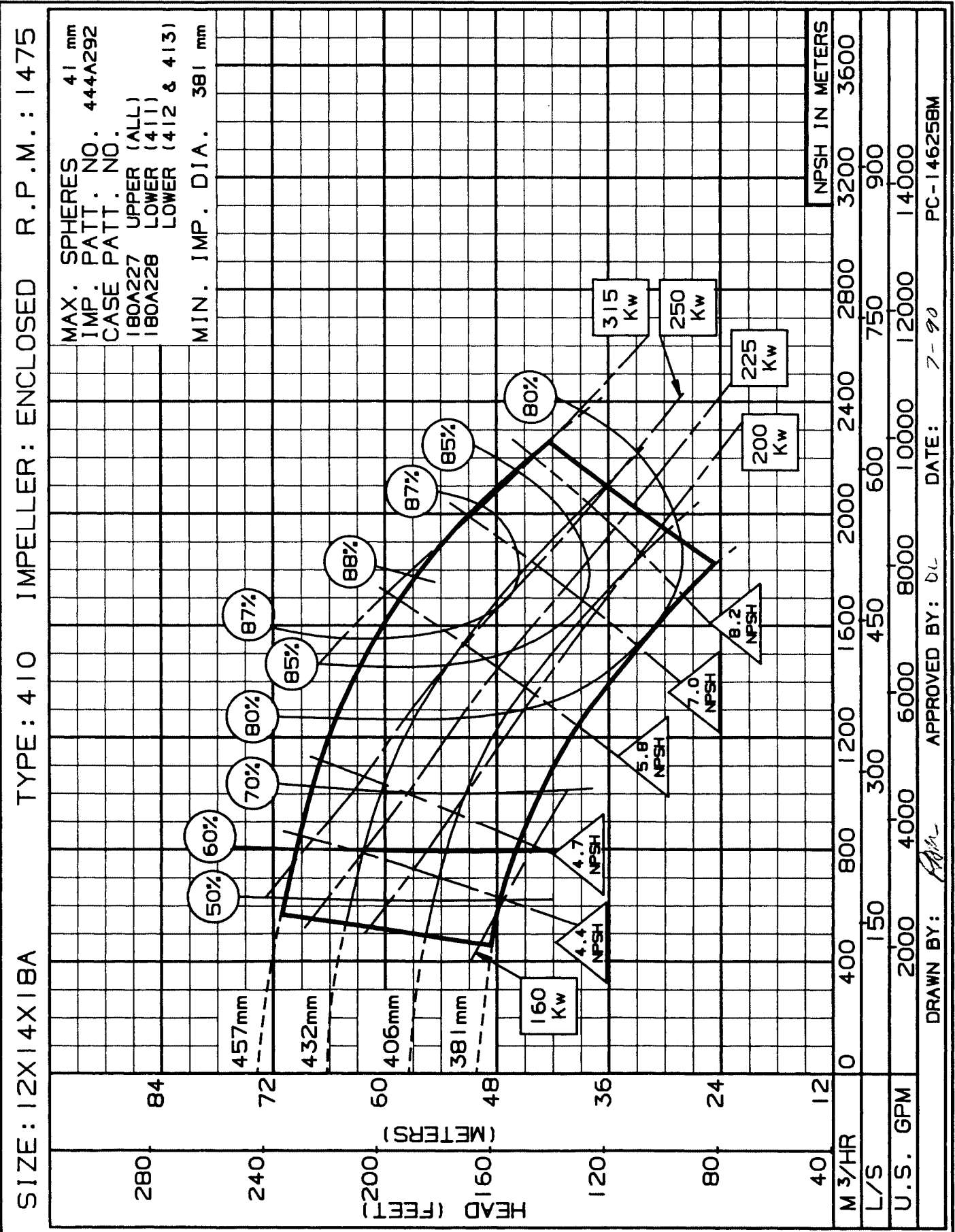

SIZE: 12X14X18A TYPE: 410 IMPELLER: ENCLOSED R.P.M.: 980

MAX. SPHERES 41 mm  
IMP. PATT. NO. 444A292  
CASE PATT. NO. 180A227 UPPER (ALL)  
180A228 LOWER (411)  
LOWER (412 & 413)  
MIN. IMP. DIA. 381 mm

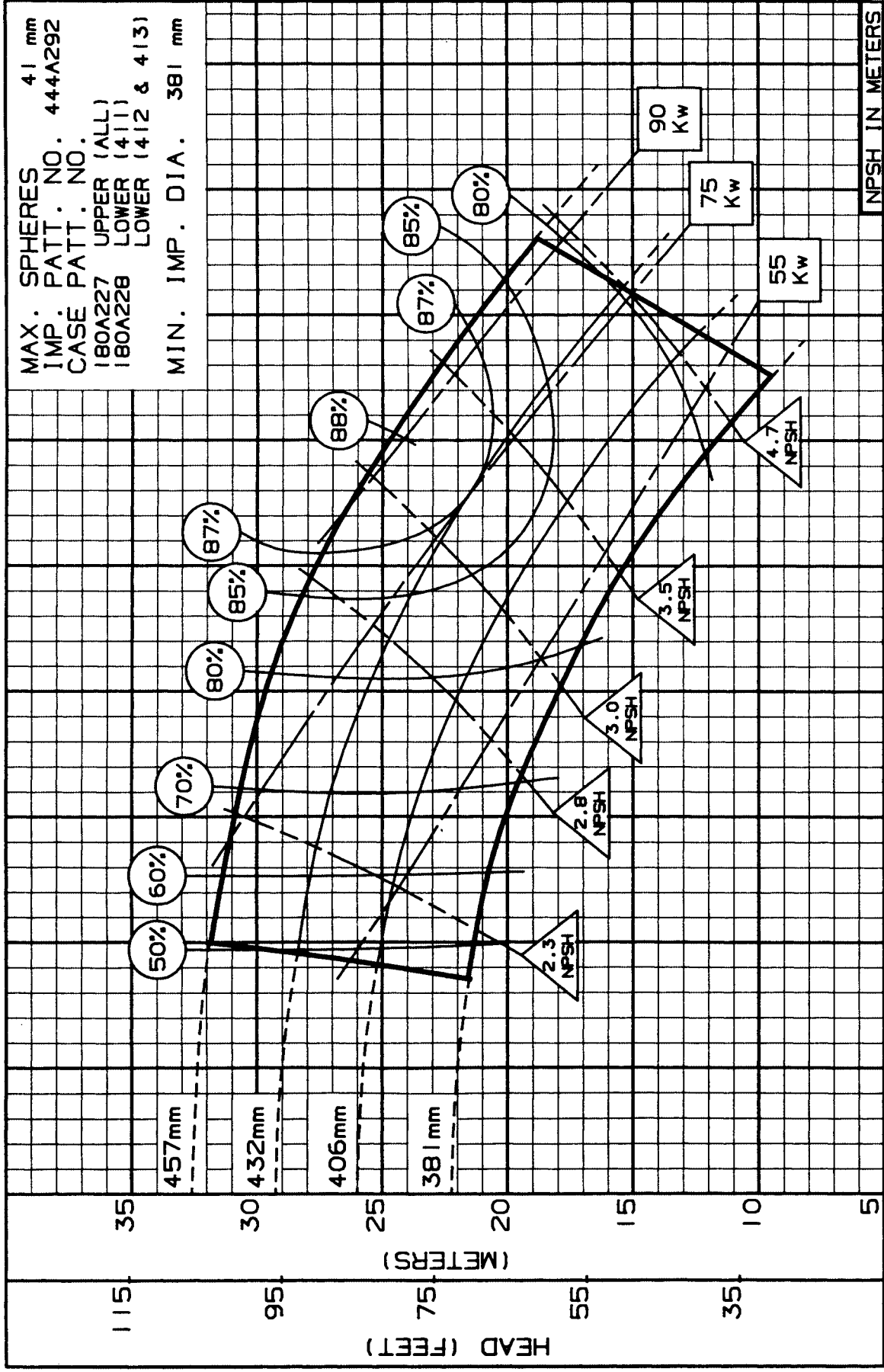

M <sup>3</sup> /HR	0	200	400	600	800	1000	1200	1400	1600	1800
L/S	60	120	180	240	300	360	420	480	540	600
U.S. GPM	1000	2000	3000	4000	5000	6000	7000	8000	9000	10000
DRAWN BY: <i>Boyl</i> APPROVED BY: DL DATE: 7-90 PC-146257M										

SIZE: 14X16X18 TYPE: 410 IMPELLER: ENCLOSED R.P.M.: 980

MAX. SPHERES 38 mm  
 IMP. PATT. NO. 444A149  
 CASE PATT. NO.  
 180A229 UPPER (ALL)  
 180A230 LOWER (411)  
 LOWER (412 & 413)  
 MIN. IMP. DIA. 381 mm

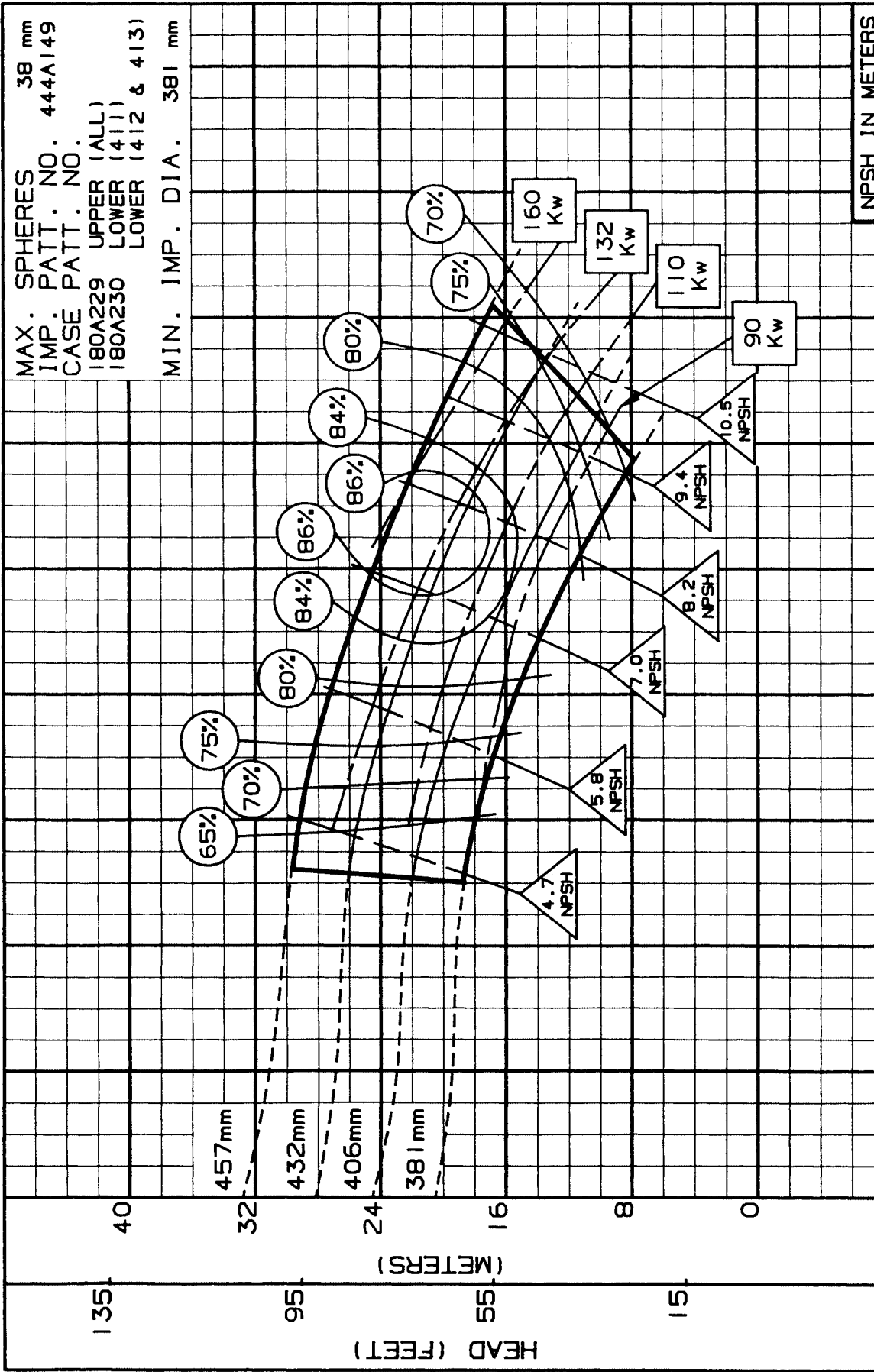

M <sup>3</sup> /HR	0	400	800	1200	1600	2000	2400	2800	3200	3600
L/S	0	150	300	450	600	800	1000	1200	1400	1500
U.S. GPM	0	2000	4000	6000	8000	10000	12000	14000	16000	18000

DRAWN BY: *RDC* APPROVED BY: *DL* DATE: 7-90 PC-132250M

SIZE: 14X16X18 TYPE: 410 IMPELLER: ENCLOSED R.P.M.: 735

MAX. SPHERES 38 mm  
IMP. PATT. NO. 444A149  
CASE PATT. NO.  
180A229 UPPER (ALL)  
180A230 LOWER (411)  
LOWER (412 & 413)  
MIN. IMP. DIA. 381 mm

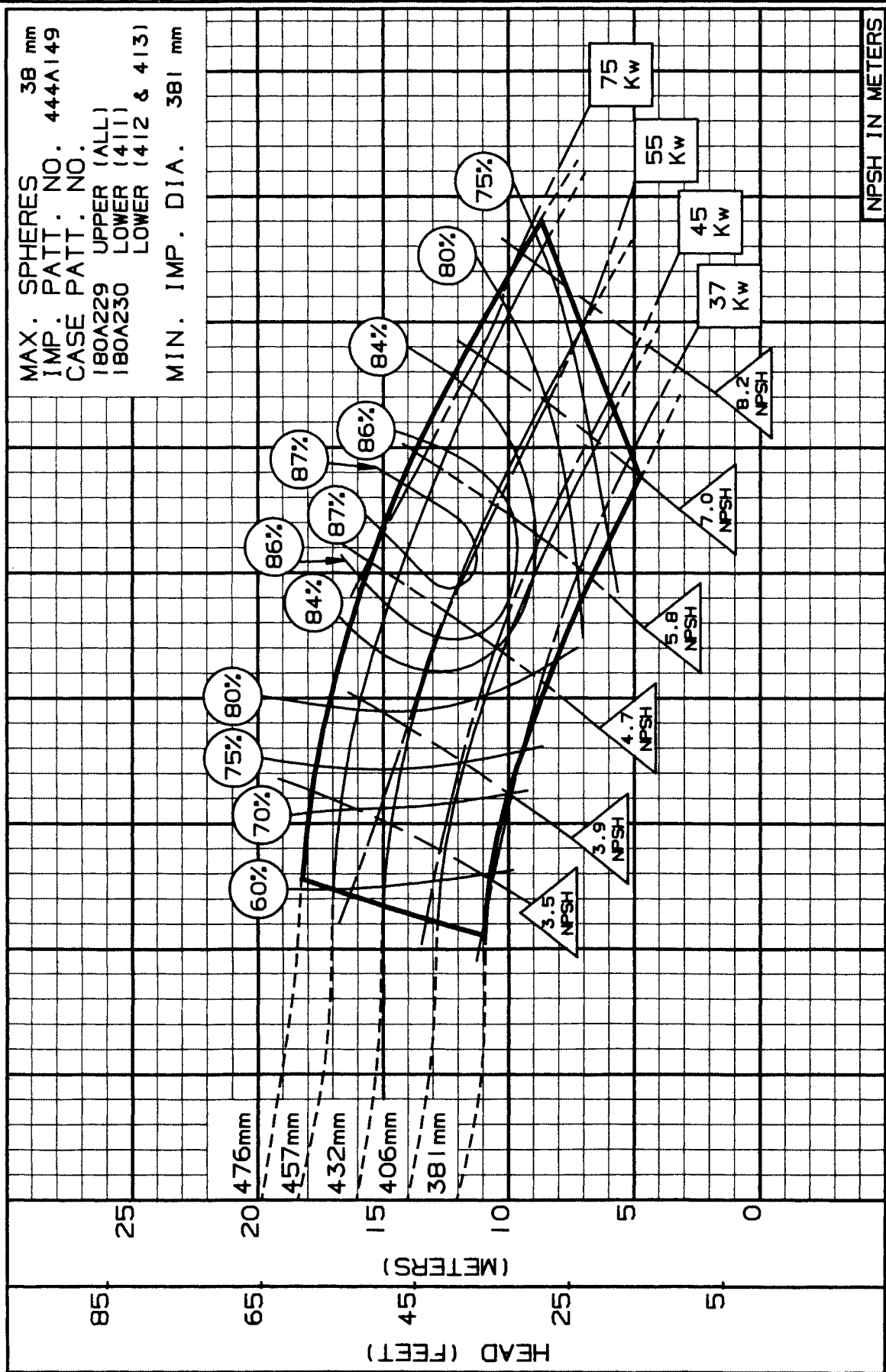

M <sup>3</sup> /HR	0	300	600	900	1200	1500	1800	2100	2400	2700
L/S	0	100	200	300	400	500	600	700	800	900
U.S. GPM	0	1500	3000	4500	6000	7500	9000	10500	12000	13500

HEAD (FEET) 5 25 45 65 85  
HEAD (METERS) 0 5 10 15 20 25  
NPSH IN METERS

DRAWN BY: *RAM* APPROVED BY: *DL* DATE: 7-90 PC-132251M